

# Computerized Embroidery Machine Operation Manual

Product Code 885-V51

brother®

1 GETTING READY

2 EMBROIDERY

3 APPENDIX

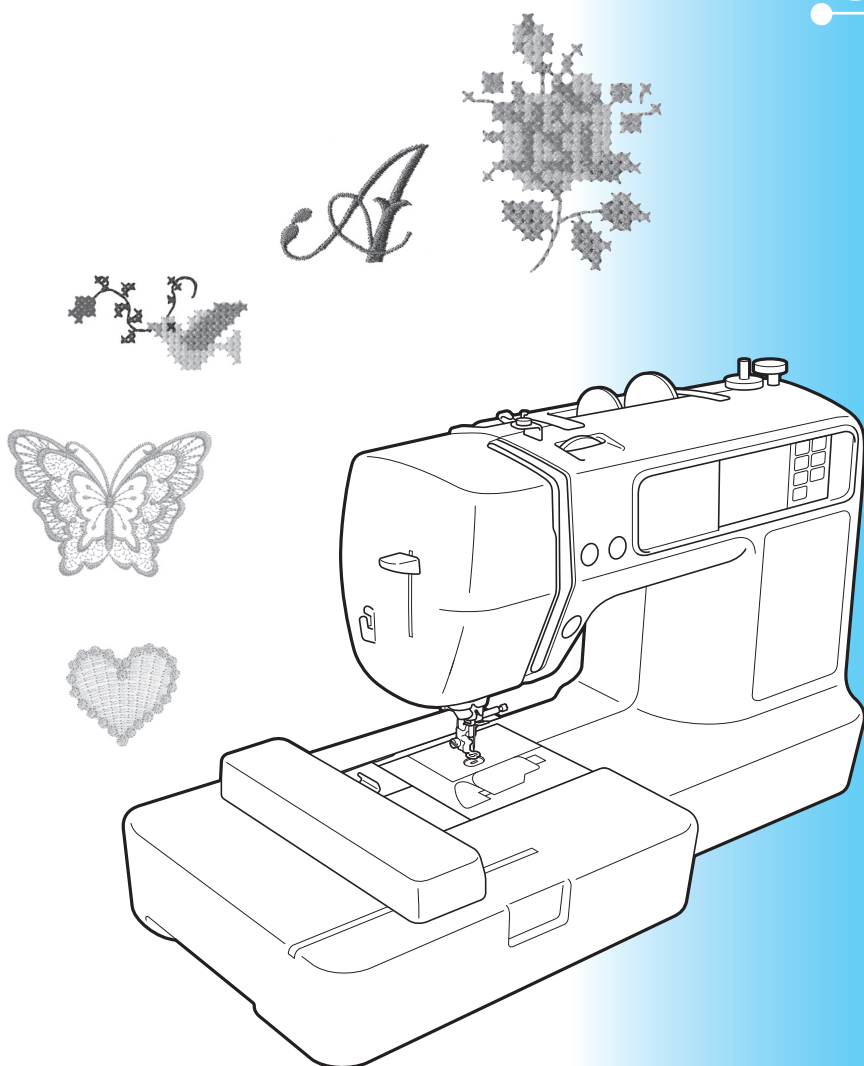

Please visit us at <http://solutions.brother.com> where you can get product support and answers to frequently asked questions (FAQs).



## Introduction

Thank you for purchasing this embroidery machine. Before using this machine, carefully read the "IMPORTANT SAFETY INSTRUCTIONS", and then study this manual for the correct operation of the various functions. In addition, after you have finished reading this manual, store it where it can quickly be accessed for future reference.

## IMPORTANT SAFETY INSTRUCTIONS

**Please read these safety instructions before attempting to use the machine.**

### **DANGER** - To reduce the risk of electric shock

- 1 Always** unplug the machine from the electrical outlet immediately after using, when cleaning, when making any user servicing adjustments mentioned in this manual, or if you are leaving the machine unattended.

### **WARNING** - To reduce the risk of burns, fire, electric shock, or injury to persons.

- 2 Always** unplug the machine from the electrical outlet when removing covers, lubricating, or when making any adjustments mentioned in the instruction manual.
  - To unplug the machine, switch the machine to the symbol "O" position to turn it off, then grasp the plug and pull it out of the electrical outlet. **Do not** pull on the cord.
  - Plug the machine directly into the electrical outlet. Do not use an extension cord.
  - **Always** unplug your machine if the power is cut.
- 3 Never** operate this machine if it has a damaged cord or plug, if it is not working properly, if it has been dropped or damaged, or water is spilled on the unit. Return the machine to the nearest authorized dealer or service center for examination, repair, electrical or mechanical adjustment.
  - While the machine is stored or in use if you notice anything unusual, such as an odor, heat, discoloration or deformation, stop using the machine immediately and unplug the power cord.
  - When transporting the machine, be sure to carry it by its handle. Lifting the machine by any other part may damage the machine or result in the machine falling, which could cause injuries.
  - When lifting the machine, be careful not to make any sudden or careless movements, otherwise you may injure your back or knees.
- 4 Always** keep your work area clear:
  - **Never** operate the machine with any air openings blocked. Keep ventilation openings of the machine free from the build up of lint, dust, and loose cloth.
  - **Do not** use extension cords. Plug the machine directly into the electrical outlet.
  - **Never** drop or insert **any** object into **any** opening.
  - **Do not** operate where aerosol (spray) products are being used or where oxygen is being administered.

- **Do not** use the machine near a heat source, such as a stove or iron; otherwise, the machine, power cord or garment being embroidered may ignite, resulting in fire or an electric shock.
- **Do not** place this machine on an unstable surface, such as an unsteady or slanted table, otherwise the machine may fall, resulting in injuries.

## **5** Special care is required when embroidering:

- **Always** pay close attention to the needle. Do not use bent or damaged needles.
- Keep fingers away from **all** moving parts. Special care is required around the machine needle.
- Switch the machine to the symbol "O" position to turn it off when making any adjustments in the needle area.
- **Do not** use a damaged or incorrect needle plate, as it could cause the needle to break.
- **Do not** push or pull the fabric when embroidering.

## **6** This machine is **not** a toy:

- Your close attention is necessary when the machine is used by or near children.
- The plastic bag that this machine was supplied in should be kept out of the reach of children or disposed of. Never allow children to play with the bag due to the danger of suffocation.
- Do not use outdoors.

## **7** For a longer service life:

- When storing this machine, avoid direct sunlight and high humidity locations. Do not use or store the machine near a space heater, iron, halogen lamp, or other hot objects.
- Use only neutral soaps or detergents to clean the machine. Benzene, thinner, and scouring powders can damage the machine, and should never be used.
- Always consult the operation manual when replacing or installing any assemblies, needle, or other parts to assure correct installation.

## **8** For repair or adjustment:

- If the light unit is damaged, it must be replaced by an authorized dealer.
- In the event a malfunction occurs or adjustment is required, first follow the troubleshooting table in the back of the operation manual to inspect and adjust the machine yourself. If the problem persists, please consult your local authorized Brother dealer.

**Use this machine only for its intended use as described in the manual.**

**Use accessories recommended by the manufacturer as contained in this manual.**

**Use only the interface cable (USB cable) included with this machine.**

**The contents of this manual and specifications of this product are subject to change without notice.**

**For additional product information and updates, visit our web site at [www.brother.com](http://www.brother.com)**

# **SAVE THESE INSTRUCTIONS**

## **This machine is intended for household use.**

---

This appliance is not intended for use by persons (including children) with reduced physical, sensory or mental capabilities, or lack of experience and knowledge, unless they have been given supervision or instruction concerning use of the appliance by a person responsible for their safety. Children should be supervised to ensure that they do not play with the appliance.

## **FOR USERS IN THE UK, EIRE, MALTA AND CYPRUS ONLY**

### **IMPORTANT**

- In the event of replacing the plug fuse, use a fuse approved by ASTA to BS 1362, i.e. carrying the  mark, rating as marked on plug.
- Always replace the fuse cover. Never use plugs with the fuse cover omitted.
- If the available electrical outlet is not suitable for the plug supplied with this equipment, you should contact your authorized dealer to obtain the correct lead.

## Federal Communications Commission (FCC) Declaration of Conformity (For USA Only)

Responsible Party: Brother International Corporation  
100 Somerset Corporate Boulevard  
Bridgewater, NJ 08807-0911 USA  
TEL : (908) 704-1700

declares that the product

Product Name: Brother Sewing Machine  
Model Number: HE1, PE500

This device complies with Part 15 of the FCC Rules. Operation is subject to the following two conditions: (1) this device may not cause harmful interference, and (2) this device must accept any interference received, including interference that may cause undesired operation.

This equipment has been tested and found to comply with the limits for a Class B digital device, pursuant to Part 15 of the FCC Rules. These limits are designed to provide reasonable protection against harmful interference in a residential installation. This equipment generates, uses, and can radiate radio frequency energy and, if not installed and used in accordance with the instructions, may cause harmful interference to radio communications. However, there is no guarantee that interference will not occur in a particular installation. If this equipment does cause harmful interference to radio or television reception, which can be determined by turning the equipment off and on, the user is encouraged to try to correct the interference by one or more of the following measures:

- Reorient or relocate the receiving antenna.
- Increase the separation between the equipment and receiver.
- Connect the equipment into an outlet on a circuit different from that to which the receiver is connected.
- Consult the dealer or an experienced radio/TV technician for help.
- The included interface cable should be used in order to ensure compliance with the limits for a Class B digital device.
- Changes or modifications not expressly approved by Brother Industries, Ltd. could void the user's authority to operate the equipment.

# Contents

<b>Introduction</b> .....	<b>1</b>
<b>IMPORTANT SAFETY INSTRUCTIONS</b> .....	<b>1</b>
<b>Machine Features</b> .....	<b>7</b>
<b>Accessories</b> .....	<b>8</b>
Included accessories .....	8
Optional accessories .....	9
<b>Names of Machine Parts and Their Functions</b> .....	<b>10</b>
Front view .....	10
Needle and embroidery foot section .....	11
Right-side/rear view .....	11
Operation buttons .....	12
Operation panel .....	13
<b>GETTING READY</b> .....	<b>15</b>
<b>Basic Steps for Embroidering</b> .....	<b>16</b>
<b>Turning the Machine On/Off</b> .....	<b>17</b>
Power supply precautions .....	17
Turning on the machine .....	18
Turning off the machine .....	18
<b>Attaching the Embroidery Unit</b> .....	<b>19</b>
Embroidery unit precautions .....	19
Attaching the embroidery unit .....	19
Removing the embroidery unit .....	21
<b>LCD (Liquid Crystal Display) Operation</b> .....	<b>22</b>
Viewing the LCD .....	22
Changing the machine settings .....	23
Checking machine operating procedures .....	25
<b>Preparing Items for embroidering</b> .....	<b>26</b>
<b>Preparing the Needle</b> .....	<b>27</b>
Needle precautions .....	27
Checking the needle .....	27
Replacing the needle .....	28
<b>Winding/Installing the Bobbin</b> .....	<b>29</b>
Bobbin precautions .....	29
Winding the bobbin .....	29
Installing the bobbin .....	34
<b>Upper Threading</b> .....	<b>37</b>
About the spool of thread .....	37
Threading the upper thread .....	38
<b>Preparing the Fabric</b> .....	<b>43</b>
Attaching a stabilizer material to the fabric .....	43
Setting the fabric in the embroidery frame .....	44
<b>Attaching the Embroidery Frame</b> .....	<b>47</b>
Attaching the embroidery frame .....	47
Removing the embroidery frame .....	48
<b>EMBROIDERY</b> .....	<b>49</b>
<b>Selecting Embroidery Patterns</b> .....	<b>50</b>
Copyright information .....	50
Embroidery pattern types .....	50
Setting for embroidering .....	51
Selecting alphanumeric characters .....	53
Selecting an embroidery pattern .....	54
Selecting a frame pattern .....	55
Using an embroidery card .....	55

<b>Embroidering</b> .....	<b>57</b>
Embroidering a pattern .....	57
Appliquéing .....	59
<b>Editing and Saving Patterns</b> .....	<b>61</b>
Adjusting the layout and the size .....	61
Adjusting the upper thread tension .....	63
Adjusting the bobbin thread tension .....	64
Connecting character patterns .....	65
Resewing .....	66
Thread runs out partway through a design .....	67
Stopping while embroidering .....	67
<b>Using the Memory Function</b> .....	<b>69</b>
Embroidery data precautions .....	69
Saving patterns .....	70
Retrieving embroidery patterns from the computer .....	71

---

**APPENDIX** **73**

<b>Care and Maintenance</b> .....	<b>74</b>
Cleaning the machine surface .....	74
Cleaning the race .....	74
<b>Attaching the Embroidery Foot</b> .....	<b>76</b>
Attaching the embroidery foot .....	76
<b>Troubleshooting</b> .....	<b>78</b>
Error messages .....	82
Adjusting the LCD .....	85
Operation beep .....	85
<b>Upgrading Your Machine's Software</b> .....	<b>86</b>
<b>Index</b> .....	<b>87</b>



## Machine Features

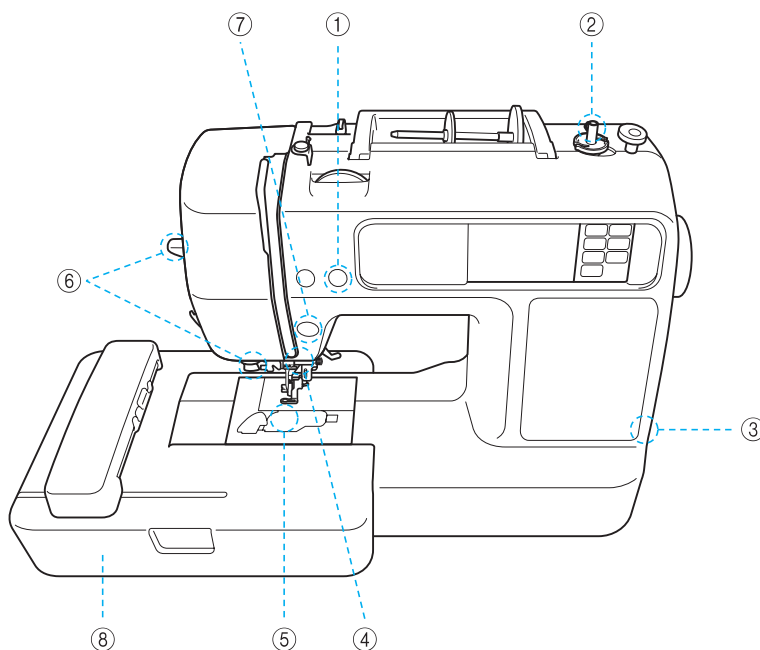

- ① **Automatic thread cutting**  
The thread can be cut automatically after embroidering (page 58).
- ② **Fast bobbin winding system**  
With the fast and simple bobbin winder, you can wind bobbins with one press of a button (page 29).
- ③ **USB port**  
Various embroidery patterns on the website or saved in your PC become available by using the USB cable (page 71).
- ④ **Bright light**  
The convenient LED lamp makes it easy to work on dark fabrics.
- ⑤ **Quick-set bobbin**  
You can start embroidering without pulling up the bobbin thread (page 34).
- ⑥ **Easy-to-use needle threader**  
You can thread the needle easily by one press of a lever (page 38).
- ⑦ **Lighting Start/Stop button**  
When the green light is on, the machine is ready to embroider. A red or orange light indicates an error or that the machine is warming up (page 12).
- ⑧ **Embroidery**  
You can embroider built-in embroidery patterns, alphanumeric characters, framed decorations, and designs from optional embroidery cards (page 49).

## Accessories

After opening the box, check that the following accessories are included. If any item is missing or damaged, contact your dealer.

### Included accessories

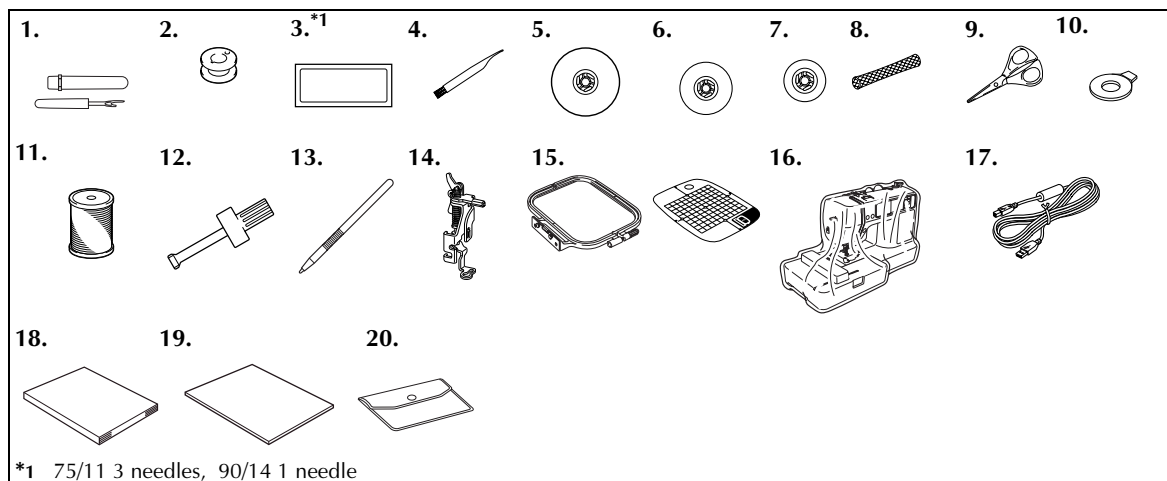

No.	Part Name	Part Code		No.	Part Name	Part Code	
		Americas	Others			Americas	Others
1	Seam ripper	XZ5082-001		13	Touch pen	XE3069-001	
2	Bobbin (4) (One is on machine.)	SA156	SFB: XA5539-151	14	Embroidery foot "Q" (on machine)	XD0474-151	
3	Needle set	X59535-051		15	Embroidery set (medium) H 10 cm X W 10 cm (H 4 inches X W 4 inches)	SA432	EF62: XA6628-102
4	Cleaning brush	X59476-021		16	Dust cover	XE5387-001	
5	Spool cap (large)	130012-024		17	USB cable	XD0745-051	
6	Spool cap (medium) (on machine)	XE1372-001		18	Operation manual	XE5427-201	
7	Spool cap (small)	130013-124		19	Quick reference guide	XE5366-001	
8	Spool net	XA5523-020		20	Accessory bag	XC4487-021	
9	Scissors	XC1807-121					
10	Disc-shaped screwdriver	XC1074-051					
11	Brother poly #90 bobbin thread	EBT-PE	EBT-PEN: XC5996-001				
12	Screwdriver	XC4237-021					

## Optional accessories

The following are available as optional accessories.

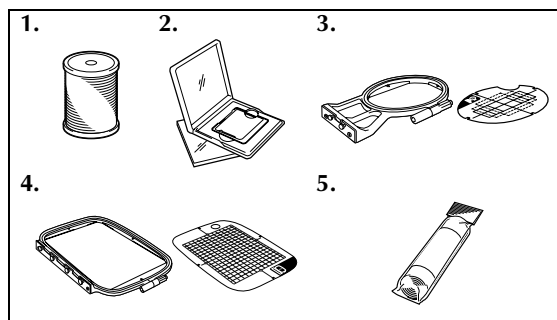

No.	Part Name	Part Code	
		Americas	Others
1	Brother poly #90 bobbin thread	EBT-PE	EBT-PEN: XC5996-001
2	Embroidery card	-	
3	Embroidery set (small) H 2 cm × W 6 cm (H 1 inch × W 2-1/2 inches)	SA431	EF61: XA6630-102
4	Embroidery set (large) H 17 cm × W 10 cm (H 6-3/4 inches × W 4 inches)	SA434	EF71: XC2026-102
5	Water soluble stabilizer	SA520	BM5: XE0615-001
	Stabilizer material for embroidery	SA519	BM3: XE0806-001



### Memo

- To obtain optional accessories or parts, contact your sales representative, the nearest authorized service center or visit the website at "<http://www.brother.com>".
- All specifications are correct at the time of printing. The part codes are subject to change without notice.
- Visit your nearest authorized dealer for a complete listing of optional accessories available for your machine.

## Names of Machine Parts and Their Functions

The names of the various parts of the machine and their functions are described below. Before using the machine, carefully read these descriptions to learn the names of the machine parts.

### Front view

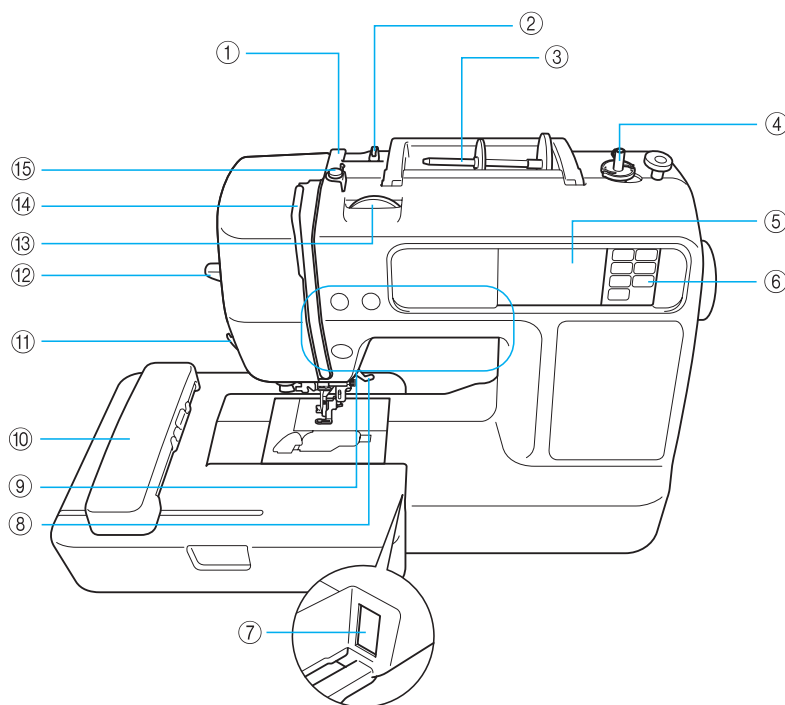

- ① **Thread guide cover (page 31, 39)**  
Pass the thread under this thread guide cover when winding the bobbin thread and threading the machine.
- ② **Thread guide (page 31, 39)**  
Pass the thread under this thread guide when winding the bobbin thread and threading the machine.
- ③ **Spool pin (page 30, 38)**  
Place a spool of thread on the spool pin.
- ④ **Bobbin winder (page 29)**  
Use the bobbin winder when winding the bobbin.
- ⑤ **LCD (liquid crystal display) (touch panel) (page 22)**  
Setting for the selected pattern and error messages appear in the LCD.
- ⑥ **Operation panel (page 13)**  
Use the keys on this panel to select embroidery patterns, or check how to use the machine, etc.
- ⑦ **Embroidery unit connector slot (page 20)**  
Plug in the connector for the embroidery unit.
- ⑧ **Presser foot lever (page 28)**  
Raise and lower the presser foot lever to raise and lower the embroidery foot.
- ⑨ **Operation buttons (page 12)**  
Use these buttons to operate the machine.
- ⑩ **Embroidery unit (page 19)**  
Attach the embroidery unit to the machine, and then attach the embroidery frame.
- ⑪ **Thread cutter (page 40)**  
Pass the threads through the thread cutter to cut them.
- ⑫ **Needle threader lever (page 41)**  
Use the needle threader lever to thread the needle.
- ⑬ **Thread tension dial (page 63)**  
Adjust the upper thread tension with this dial.
- ⑭ **Thread take-up lever (page 40)**
- ⑮ **Bobbin-winding thread guide and pretension disc (page 31)**  
Pass the thread under this thread guide and around the pretension disc when winding the bobbin thread.

## Needle and embroidery foot section

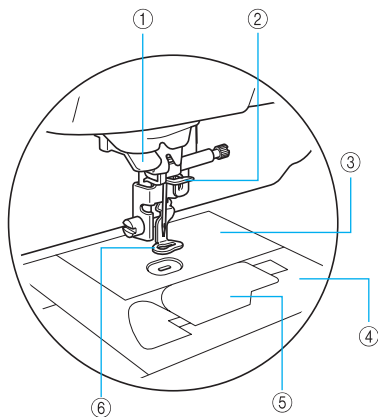

- ① **Thread guide disk (page 40)**  
Pass the thread through the thread guide disk when using the needle threader to thread the needle.
- ② **Needle bar thread guide (page 40)**  
Pass the upper thread through the needle bar thread guide.
- ③ **Needle plate**  
When the needle is lowered, it enters the hole in the needle plate.
- ④ **Needle plate cover (page 74)**  
Remove the needle plate cover to clean the bobbin case and race.
- ⑤ **Bobbin cover/bobbin case (page 35)**  
Remove the bobbin cover, and then insert the bobbin into the bobbin case.
- ⑥ **Embroidery foot "Q" (page 76)**  
This presser foot is used for embroidering.

## Right-side/rear view

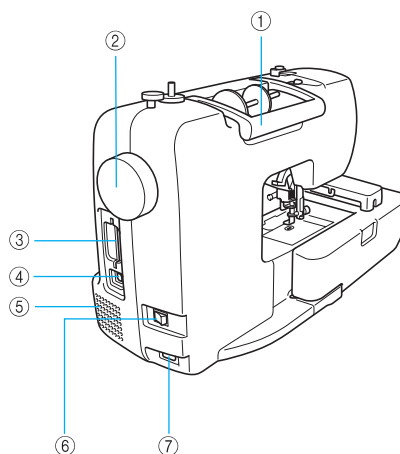

- ① **Handle**  
Carry the machine by its handle when transporting the machine.
- ② **Handwheel (page 38)**  
Turn the handwheel toward you (counterclockwise) to raise and lower the needle.
- ③ **Embroidery card slot (page 55)**  
Insert the embroidery card.
- ④ **USB port (page 71)**  
Connect the one end of the USB cable to this port and the other to the computer.
- ⑤ **Air vent**  
The air vent allows the air surrounding the motor to be exchanged. Do not cover the air vent while the machine is being used.
- ⑥ **Main power switch (page 18)**  
Use the main power switch to turn the machine on and off.
- ⑦ **Power supply jack (page 18)**  
Insert the plug on the power supply cord into the power supply jack.





### Memo

- Refer to pages 10 through 13 while you are learning to use your machine.

## Operation buttons

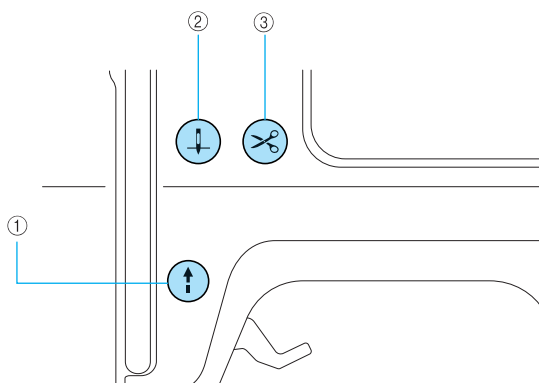
The operation buttons help you to easily perform various basic machine operations.





- ① **Start/stop button** 
- Press the start/stop button to start or stop embroidering. The machine embroiders at a slow speed while the button is pressed. When embroidering is stopped, the needle is lowered in the fabric. The button changes color according to the machine's operation mode.

Green: The machine is ready to embroider or is embroidering.

Red: The machine can not embroider.

Orange: The machine is winding the bobbin thread, or the bobbin winder shaft is moved to the right side.

- ② **Needle position button** 
- Press the needle position button to raise or lower the needle. Be sure to raise the needle before threading the needle. Pressing the button twice sews one stitch.
- ③ **Thread cutter button** 
- Press the thread cutter button after embroidering is stopped to cut both the upper thread and the bobbin threads.

### CAUTION

- Do not press the thread cutter button after the threads have already been cut, otherwise the needle may break, the threads may become tangled or damage to the machine may occur.





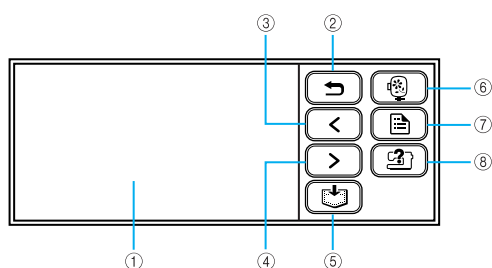

### Note

- Do not press the thread cutter button if there is no fabric under the embroidery foot or while the machine is embroidering, otherwise damage to the machine may occur.
- When cutting nylon thread or other special threads, use the thread cutter on the side of the machine.

## Operation panel

The front operation panel has an LCD (liquid crystal display) and operation keys.



- ① **LCD (liquid crystal display) (touch panel)**  
Setting for the selected pattern and error messages appear in the LCD.  
Touch the keys displayed on the LCD with your finger or a touch pen to perform operations.  
For details, refer to "LCD (Liquid Crystal Display) Operation" (page 22).
- ② **Back key**   
Press to return to the previous screen.
- ③ **Previous page key**   
Press to display the previous page when there are items that are not displayed on the LCD.
- ④ **Next page key**   
Press to display the next page when there are items that are not displayed on the LCD.
- ⑤ **Memory key**   
Press to save embroidery patterns and the alphanumeric characters in the machine's memory.
- ⑥ **Embroidery key**   
Press to display the pattern type selection screen.
- ⑦ **Settings key**   
Press to display the settings screen.
- ⑧ **Help key**   
Press to get help on using the machine. Displays simple explanations of setting upper thread / bobbin winding / setting bobbin thread / embroidery unit attachment / embroidery frame attachment / needle replacement.







# GETTING READY

The various preparations to start embroidering are described in this chapter.

<b>Basic Steps for Embroidering.....</b>	<b>16</b>
<b>Turning the Machine On/Off .....</b>	<b>17</b>
<b>Attaching the Embroidery Unit.....</b>	<b>19</b>
<b>LCD (Liquid Crystal Display) Operation.....</b>	<b>22</b>
<b>Preparing Items for Embroidering .....</b>	<b>26</b>
<b>Preparing the Needle.....</b>	<b>27</b>
<b>Winding/Installing the Bobbin.....</b>	<b>29</b>
<b>Upper Threading .....</b>	<b>37</b>
<b>Preparing the Fabric.....</b>	<b>43</b>
<b>Attaching the Embroidery Frame.....</b>	<b>47</b>

## Basic Steps for Embroidering

This section describes the preparations for embroidering.  
The basic steps for embroidering are as follows.

<b>1</b>	<b>Embroidery unit attachment</b>	Attach the embroidery unit. For details, refer to "Attaching the embroidery unit" (page 19).
↓		
<b>2</b>	<b>Needle preparation</b>	Use a needle matched to the fabric. For details, refer to "Replacing the needle" (page 28).
↓		
<b>3</b>	<b>Bobbin thread setup</b>	For the bobbin thread, wind embroidery bobbin thread and set it in place. For details, refer to "Winding/Installing the Bobbin" (page 29).
↓		
<b>4</b>	<b>Fabric preparation</b>	Attach a stabilizer material to the fabric, and hoop it in an embroidery frame. For details, refer to "Preparing the Fabric" (page 43).
↓		
<b>5</b>	<b>Embroidery frame attachment</b>	Attach the embroidery frame to the embroidery unit. For details, refer to "Attaching the Embroidery Frame" (page 47).
↓		
<b>6</b>	<b>Pattern selection</b>	Select an embroidery pattern. For details, refer to "Selecting Embroidery Patterns" (page 50).
↓		
<b>7</b>	<b>Upper thread setup</b>	Set up the upper thread according to the selected pattern. For details on setting up the thread, refer to "Upper Threading" (page 37).
↓		
<b>8</b>	<b>Checking the layout</b>	Check and adjust the size and position of the embroidery pattern. For details, refer to "Adjusting the layout and the size" (page 61).

## Turning the Machine On/Off

This section explains how to turn the machine on and off.

### Power supply precautions

Be sure to observe the following precautions concerning the power supply.

#### WARNING

- Use only regular household electricity for the power source. Using other power sources may result in fire, electric shock, or damage to the machine.
- Make sure that the plugs on the power cord are firmly inserted into the electrical outlet and the power supply jack on the machine.
- Do not insert the plug on the power cord into an electrical outlet that is in poor condition.
- Turn off the main power and remove the plug in the following circumstances:
  - When you are away from the machine
  - After using the machine
  - When the power fails during use
  - When the machine does not operate correctly due to a bad connection or a disconnection
  - During electrical storms

#### CAUTION

- Use only the power cord included with this machine.
- Do not use extension cords or multi-plug adapters with many other appliances plugged in to them. Fire or electric shock may result.
- Do not touch the plug with wet hands. Electric shock may result.
- When unplugging the machine, always turn off the main power first. Always grasp the plug to remove it from the outlet. Pulling on the cord may damage the cord, or lead to fire or electric shock.
- Do not allow the power cord to be cut, damaged, modified, forcefully bent, pulled, twisted, or bundled. Do not place heavy objects on the cord. Do not subject the cord to heat. These things may damage the cord and cause fire or electric shock. If the cord or plug is damaged, take the machine to your authorized dealer for repairs before continuing use.
- Unplug the power cord if the machine is not to be used for a long period of time. Otherwise a fire may result.

## Turning on the machine



### Memo

- Before turning on the machine, be sure to attach the embroidery unit to it. If the embroidery unit is not attached, the machine does not operate. (For details, refer to "Attaching the Embroidery Unit" (page 19).)

Prepare the included power supply cord.

- 1 **Make sure that the machine is turned off (the main power switch is set to "O"), and then plug the power supply cord into the power supply jack on the right side of the machine.**
- 2 **Insert the plug of the power supply cord into a household electrical outlet.**

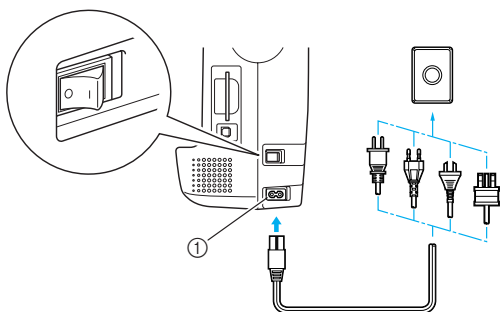

① Power supply jack

- 3 **Press the right side of the main power switch on the right side of the machine to turn the machine on (set it to "I").**

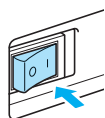

- ▶ The light, LCD and ⓘ (Start/stop button) light up when the machine is turned on.



### Memo

- When the machine is turned on, the needle will make sound when it moves; this is not a malfunction.

## Turning off the machine

When you have finished using the machine, turn it off. In addition, before transporting the machine to another location, be sure to turn it off.

- 1 **Make sure that the machine is completely stopped.**
- 2 **Press the left side of the main power switch on the right side of the machine to turn the machine off (set it to "O").**

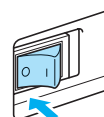

- ▶ The light, LCD and ⓘ (Start/stop button) go off when the machine is turned off.

- 3 **Unplug the power supply cord from the electrical outlet.**  
Grasp the plug when unplugging the power supply cord.
- 4 **Unplug the power cord from the power supply jack.**



### Note

- If a power outage occurs while the machine is being operated, turn off the machine and unplug the power supply cord. When restarting the machine, follow the necessary procedure to correctly operate the machine.

(For U.S.A. only)

- This appliance has a polarized plug (one blade wider than the other). To reduce the risk of electrical shock, this plug is intended to fit in a polarized outlet only one way. If the plug does not fit fully in the outlet, reverse the plug. If it still does not fit, contact a qualified electrician to install the proper outlet. Do not modify the plug in any way.

# Attaching the Embroidery Unit

This section describes how to attach the embroidery unit.

## Embroidery unit precautions

### CAUTION

- Do not move the machine with the embroidery unit in place. The embroidery unit may be dropped and cause injury.
- Keep your hands and other objects away from the embroidery carriage and frame. Otherwise injury may result.



### Note

- Do not touch the connector in the embroidery unit connector slot. The connector could be damaged, and it may cause malfunctions.
- Do not lift up on the embroidery carriage, and do not forcefully move it. It may cause malfunctions.

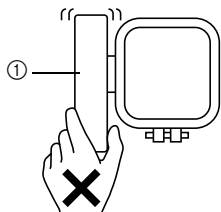

① Carriage

## Attaching the embroidery unit

Get the embroidery unit ready.

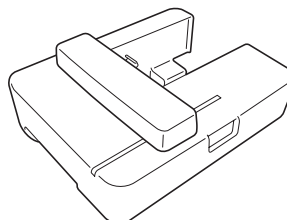

- 1 Make sure that the machine is turned off.

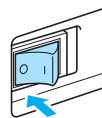

### Memo

- Always turn off the machine before attaching the embroidery unit. It may cause malfunctions.

## 2 Slide the embroidery unit onto the machine arm.

Push it in until it clicks and stops.

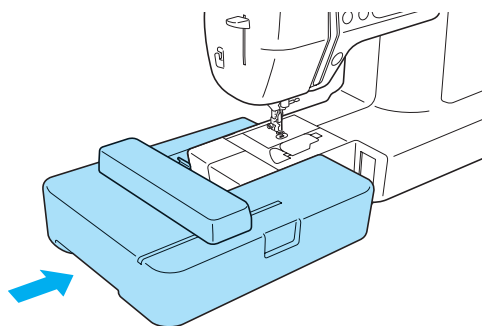

- ▶ The embroidery unit is attached.



### Note

- Make sure that there is no gap between the embroidery unit and the machine, otherwise the embroidery pattern may not be sewn correctly.  
Be sure to fully insert the connector into the connection port.
- Do not push on the carriage when attaching the embroidery unit to the machine, otherwise damage to the embroidery unit may result.

## 3 Turn on the machine.

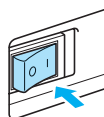

- ▶ The confirmation message is displayed.

## 4 Be sure that no objects or hands are near the embroidery unit and press **OK**.

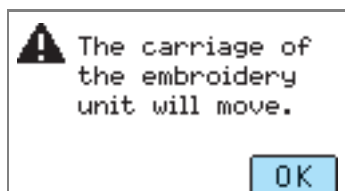

- ▶ The carriage moves to its initial position.

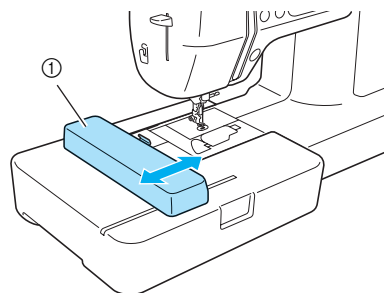

① Carriage

## CAUTION

- Do not put your hands or other objects near the carriage. It may cause injury.



### Note

- If the machine is initialized with hands or objects near the carriage, the screen may return to the initial display. After removing whatever is near the carriage, turn the power on again.

- ▶ The screen for selecting the embroidery pattern type is displayed.

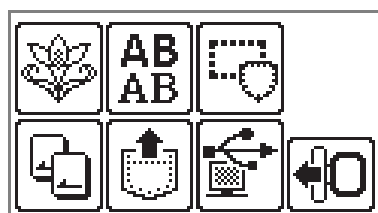

### Memo

- For details on the embroidery patterns, refer to "Selecting Embroidery Patterns" (page 50).

## Removing the embroidery unit

Make sure that the machine is completely stopped and follow the instructions below.

### 1 Remove the embroidery frame.

- For details on removing the embroidery frame, refer to "Removing the embroidery frame" (page 48).

### 2 Press , and then press .

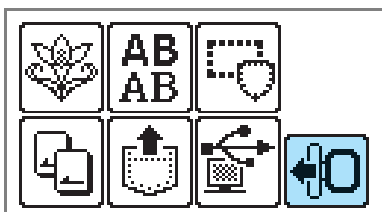

- ▶ The embroidery carriage moves into a position where it can be saved.

### 3 Turn off the machine.

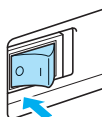

## CAUTION

- Always turn off the machine before removing the embroidery unit. It may cause malfunctions if removed when the machine is turned on.

### 4 Hold the release button on the bottom left of the embroidery unit, and slowly pull the embroidery unit to the left.

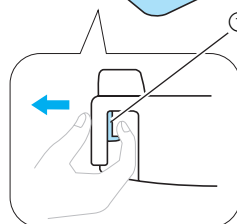
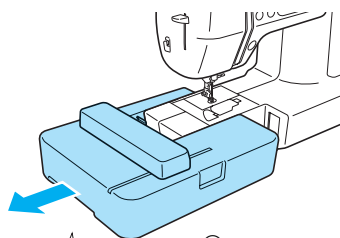

- ① Release button
- ▶ The embroidery unit separates from the machine.

## CAUTION

- Do not carry the embroidery unit by holding the carriage. It may cause malfunctions.

## LCD (Liquid Crystal Display) Operation

Selected embroidery pattern, settings and messages are displayed on the LCD (liquid crystal display) on the front of the machine. Change the screen on the LCD using the keys on the right side of the LCD, and make operations by directly touching the icons with your finger or a touch pen. For details, refer to "Operation panel" (page 13).

### Viewing the LCD

When the power is turned on, the LCD comes on. When you touch the LCD screen according to the message displayed on the screen with your finger or a touch pen, the following screen is displayed.



#### ① Pattern type selection

You can select the pattern type from this screen.  
For details, refer to "Embroidery pattern types" (page 50).

#### ② Moves the embroidery unit carriage to its storage position

Press when removing the embroidery unit.  
For details, refer to "Removing the embroidery unit" (page 21).



#### Memo







- Refer to "Error messages" (page 82) for messages displayed on the LCD.



## Changing the machine settings

Various machine operations and settings can be changed.

The attributes that can be set are listed below. For details on operation, refer to page 24.

Attribute	Icon	Details	Settings
Thread color display		Changes the thread color display (page 51).	Thread color/Time to embroider/Needle count/Thread number (#123)
		(When "Thread No.#123" is selected)	Embroidery/Country/Madeira poly/Madeira rayon/Sulky/Robison Anton
Display unit		Selects the measurement units that are displayed (page 52).	mm/INCH
Buzzer		Specifies whether or not a beep is sounded with each operation (page 85).	<b>ON OFF</b>
Language		Allows the language used in the screens to be changed.	English/German/French/Italian/Dutch/Spanish/Japanese/Danish/Norwegian/Finnish/Swedish/Portuguese/Russian/Korean/Thai/others
LCD brightness		Adjust the brightness of the LCD (page 85).	Lighter <input type="checkbox"/> <input type="checkbox"/> Darker
Stitch counter		Display the service count which is a reminder to take your machine in for regular servicing. (Contact your nearest authorized service center for details.)	-
		Display the total number of embroidery stitches.	-
Product number	NO.:	The "NO." is the number for the machine.	-
Program version	Version:	Displays the program version.	-



### Memo

- The item shown in reverse highlighting are the settings at the time of purchase.
- For details on the setting while embroidering, refer to "Setting for embroidering" (page 51).

## 1 Turn on the machine.

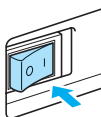

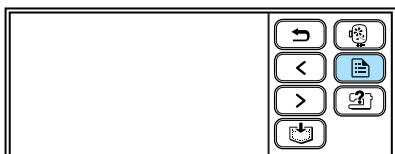

▶ The LCD comes on.

## 2 Press (Settings key) on the operation panel.



▶ The setting screen appears.

## 3 Press the item to be set.

Switch the screen using  (Previous page key) and  (Next page key).

- The following screens show their default settings.

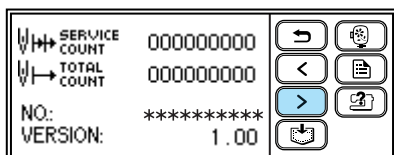
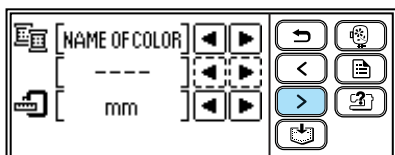

## Example: Changing the measurement unit



## 4 When settings are complete, press (Back key).



▶ The initial screen appears again.



### Memo

- "NO." is the individual number for the machine.
- "VERSION" is the program version which is installed in the machine.
- Settings that are changed are saved even if the power is turned off.

## Checking machine operating procedures

Simple explanations can be referred on the LCD display for the following items.  
Displays simple explanations of setting upper thread / bobbin winding / setting bobbin thread / embroidery unit attachment / embroidery frame attachment / needle replacement on the LCD.

### 1 Turn on the machine.

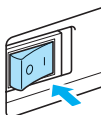

▶ The LCD comes on.

### 2 Press (Help key) on the operation panel.

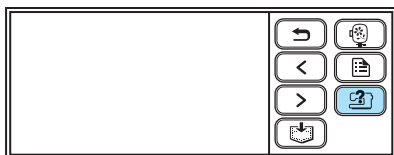

▶ The help screen appears.

### 3 Press the item to be displayed.

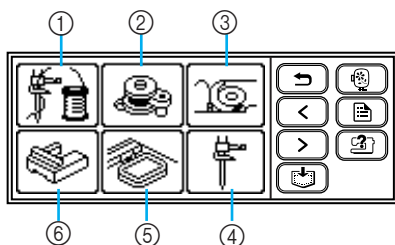

- ① Upper threading
- ② Bobbin winding
- ③ Bobbin installation
- ④ Needle replacement
- ⑤ Embroidery frame attachment
- ⑥ Embroidery unit attachment

▶ The first screen describing the procedure for the selected topic appears.

### 4 Press (Next page key) to switch to the next page.

Press  (Previous page key) to return to the previous page.

Press  (Back key) to return to the item selection screen.

### Example: Upper threading

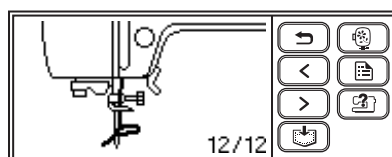
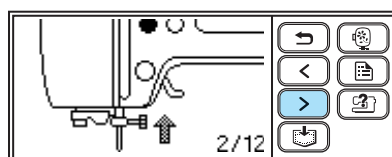
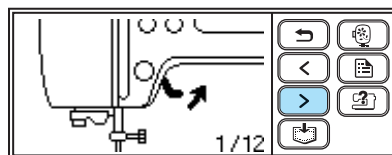

### 5 After you finish viewing, press (Back key) two times.

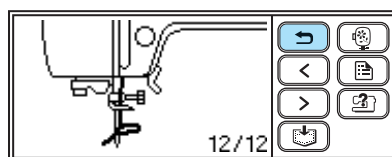

▶ The initial screen appears again.



### Memo

- For details on each topic, refer to the corresponding page in this Operation Manual.

## Preparing Items for Embroidering

The following is necessary for embroidering.

### ■ Fabric

Prepare the fabric for embroidery. Prepare a piece of fabric a little larger than the embroidery frame that matches the size of the pattern you want to embroider.



#### Note

- Always use stabilizer when embroidering projects, especially when embroidering on lightweight or stretch fabrics.



### CAUTION

- **Do not embroider fabrics that are too thick. To check the fabric thickness, attach the embroidery frame to the embroidery unit, and use  (Needle position button) to raise the needle. If there is space between the embroidery foot and the fabric, the fabric can be embroidered. If there is not space, do not embroider the fabric. Otherwise, the needle may break, resulting in injury.**
- **Be careful when embroidering overlapping patterns. The needle may not easily pierce the fabric, causing the needle to break.**

### ■ Stabilizer material (option)

Attach a stabilizer material for embroidery to the fabric to prevent poor quality embroidery designs.



Use a water soluble sheet on thin materials like organdy and fabrics with a nap like towels. For details, refer to "Attaching a stabilizer material to the fabric" (page 43).

### ■ Embroidery thread (option)

For the upper thread, use the embroidery thread or country thread.

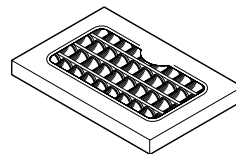

For the bobbin thread, use the embroidery bobbin thread. For details, refer to "Optional accessories" (page 9).



#### Memo

- For good quality embroidery designs be sure to use embroidery thread designed for embroidery machines.
- Before starting to embroider, be sure there is enough bobbin thread. If you continue embroidering when the bobbin thread is low, the thread may become tangled.

### ■ Needle

Use a 75/11 home sewing machine needle. When embroidering on thick fabrics such as denim, use a 90/14 home sewing machine needle.



#### Memo

- A 75/11 needle is already installed when the machine is purchased.
- When replacing the needle, refer to "Replacing the needle" (page 28).

### ■ Other

Embroidery frames "small" and "large" are optional. For details, refer to "Setting the fabric in the embroidery frame" (page 44).

# Preparing the Needle

Before starting embroidering, check the needle and replace it if necessary.

## Needle precautions

Be sure to observe the following precautions concerning the handling of the needle. Failure to observe these precautions is extremely dangerous, for example, if the needle breaks and fragments are dispersed. Be sure to read and carefully follow the instructions below.

### ! CAUTION

- Only use home sewing machine needles. Use of any other needle may bend the needle or damage the machine.
- Never use bent needles. Bent needles can easily break, possibly resulting in injuries.

## Checking the needle

Embroidering with a bent needle is extremely dangerous since the needle may break while the machine is being operated. Before using the needle, place the flat side of the needle on a flat surface and check that the distance between the needle and the flat surface is even.

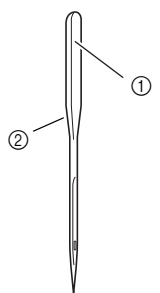

- ① Flat side
- ② Needle type marking

### ! CAUTION

- If the distance between the needle and the flat surface is not even, the needle is bent. Do not use a bent needle.

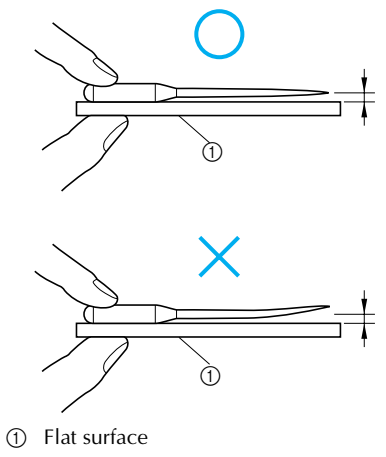

## Replacing the needle

Use the screwdriver and a needle that has been determined to be straight according to the instructions in "Checking the needle" (page 27).

- 1 Press  (Needle position button) once or twice to raise the needle.

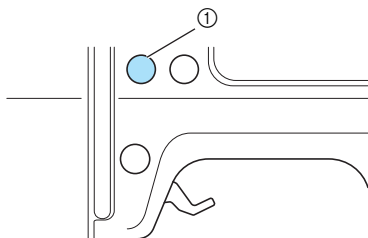

① Needle position button

- 2 Turn off the machine.

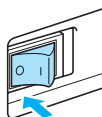

### CAUTION

- Before replacing the needle, be sure to turn off the machine. Otherwise, injuries may occur if one of the operation buttons is accidentally pressed and the machine starts embroidering.

- 3 Place fabric or paper under the embroidery foot and cover the hole on the needle plate.



#### Note

- Before replacing the needle, be sure to cover the hole in the needle plate with fabric or paper to prevent the needle from falling into the machine.

- 4 Lower the presser foot lever.

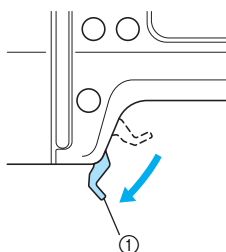

① Presser foot lever

- 5 Hold the needle with your left hand, and then use a screwdriver to turn the needle clamp screw toward you (counterclockwise) to remove the needle.

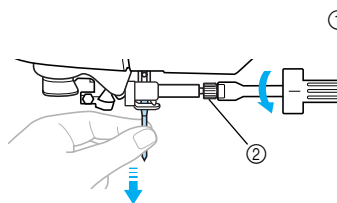

- ① Screwdriver  
② Needle clamp screw

- Do not apply a strong force when loosening or tightening the needle clamp screw, otherwise certain parts of the machine may be damaged.

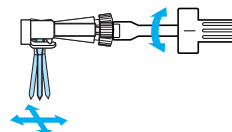

- 6 With the flat side of the needle toward the rear of the machine, insert the needle until it touches the needle stopper.

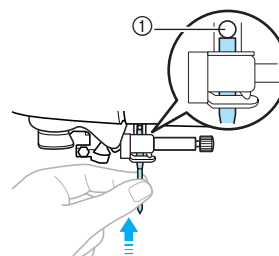

- ① Needle stopper

- 7 While holding the needle with your left hand, use the screwdriver to tighten the needle clamp screw.

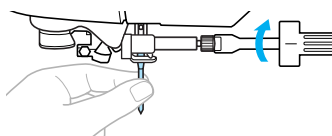

### CAUTION

- Be sure to insert the needle until it touches the needle stopper and securely tighten the needle clamp screw with the screwdriver. Otherwise, the needle may break or damage may result.

## Winding/Installing the Bobbin

This section describes how to wind the thread onto the bobbin, and then insert the bobbin thread.

### Bobbin precautions

Be sure to observe the following precautions concerning the bobbin.

#### CAUTION

- Only use the Bobbin (part code: SA156, SFB (XA5539-151)) designed specifically for this machine. Use of any other bobbin may result in injuries or damage to the machine.
- The included bobbin was designed specifically for this machine. If bobbins from other models are used, the machine will not operate correctly. Use only the included bobbin or bobbins of the same type (part code: SA156, SFB (XA5539-151)).

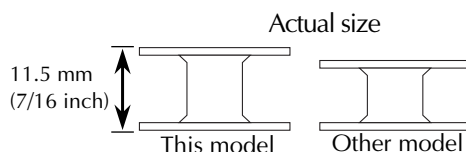

### Winding the bobbin

Wind the thread around the bobbin to prepare the bobbin thread.

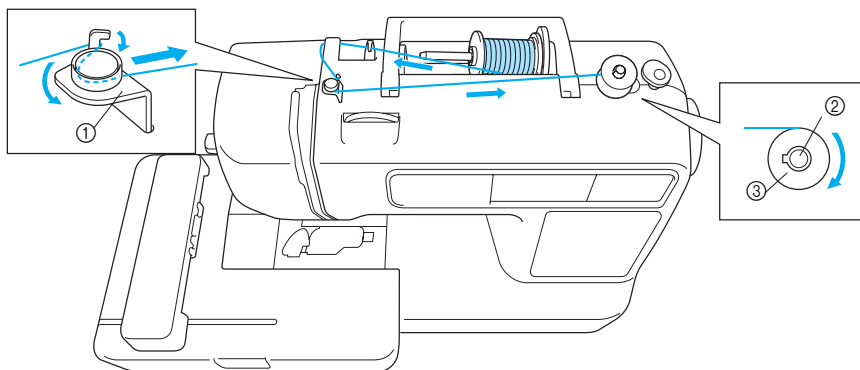

#### Memo

- Use embroidery bobbin thread intended for this machine to get attractive finishes. If you use other threads, the pattern may not turn out correctly. For details, refer to "Optional accessories" (page 9).

- 1 Turn on the machine.

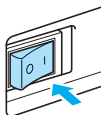

- 2 Place the bobbin on the bobbin winder shaft so that the spring on the shaft fits into the notch in the bobbin. Press down on the bobbin until it snaps into place.

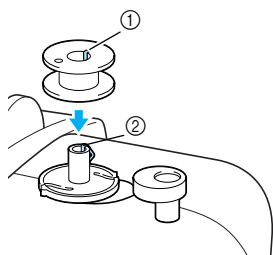

- ① Notch  
② Bobbin winder shaft spring

- 3 Slide the bobbin winder in the direction of the arrow until it snaps into place.

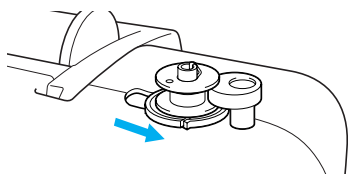

- ▶ (Start/stop button) lights up in orange.

- 4 Pick up the spool pin and remove the spool cap that is inserted onto the spool pin.

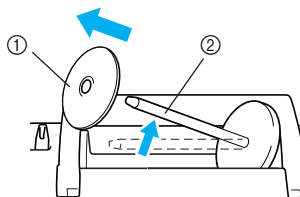

- ① Spool cap  
② Spool pin

- 5 Place the spool of thread for the bobbin onto the spool pin.

Slide the spool onto the pin so that the spool is horizontal and the thread unwinds to the front at the bottom.

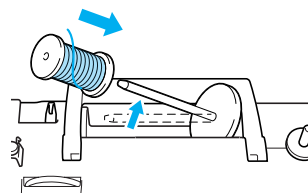

### Memo

- Use the embroidery bobbin thread for embroidering.



### Note

- If the spool is not positioned so that the thread unwinds correctly, the thread may become tangled around the spool pin.

- 6 Slide the spool cap onto the spool pin and return the spool pin to its original position. Slide the spool cap as far as possible to the right as shown, with the rounded side on the left.

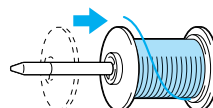

### CAUTION

- If the spool or the spool cap is not positioned correctly, the thread may become tangled around the spool pin or the machine may be damaged.
- Three spool cap sizes are available, allowing you to choose a spool cap that best fits the size of spool being used. If the spool cap is too small for the spool being used, the thread may catch on the slit in the spool or the machine may be damaged.

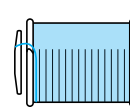
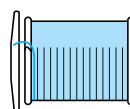





## Note

- When embroidering with fine, cross-wound thread, use the small spool cap, and leave a small space between the cap and the spool.

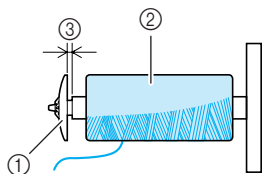

- ① Spool cap (small)
- ② Spool (cross-wound thread)
- ③ Space

- When using thread that winds off quickly, such as transparent nylon thread or metallic thread, place the spool net over the spool before placing the spool of thread onto the spool pin. If the spool net is too long, fold it to fit the size of the spool. When the spool net is used, the upper thread tension may become tighter. Before embroidering, refer to "Adjusting the upper thread tension" (page 63).

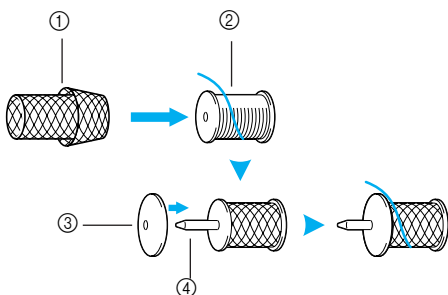

- ① Spool net
- ② Spool
- ③ Spool cap
- ④ Spool pin

## 7 Pull the thread from the spool and pass the thread under the hook of thread guide.

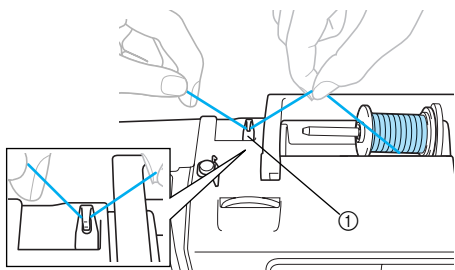

- ① Thread guide

## 8 Pass the thread behind the thread guide cover and to the front.

While holding the thread near the spool with your right hand, pull the thread with your left hand as shown below.

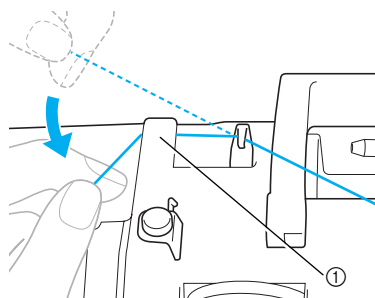

- ① Thread guide cover

## 9 Pull the thread to the right, pass it under the hook of the bobbin-winding thread guide, and then wind the thread counterclockwise under the pretension disc, pulling it in as far as possible.

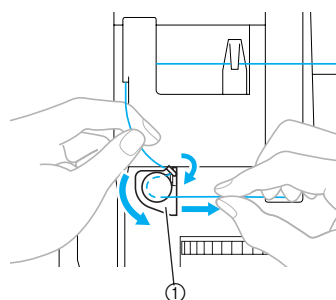

- ① Bobbin-winding thread guide

Make sure that the thread passes under the pretension disk.

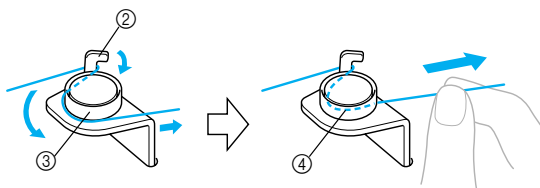

- ② Hook
- ③ Pretension disk
- ④ Pull it in as far as possible.

### 10 Wind the end of the thread clockwise around the bobbin five or six times.

While using your left hand to hold the thread that was passed through the bobbin-winding thread guide, use your right hand to wind the end of the thread.

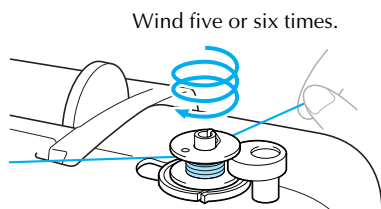

### CAUTION

- Be sure to pull the thread tightly and wind it clockwise. If the thread is wound counterclockwise, the thread may wind around the bobbin winder shaft.

### 11 Pass the end of the thread through the guide slit in the bobbin winder seat, and then pull the thread to the right to cut it.

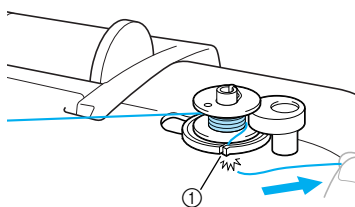

- ① Guide slit in bobbin winder seat (with built-in cutter)

### CAUTION

- Be sure to cut the thread as described. If the bobbin is wound without cutting the thread using the cutter built into the slit in the bobbin winder seat, the thread may become tangled in the bobbin or the needle may bend or break when the bobbin thread starts to run out.



### Memo

- Make sure that the thread is correctly set before starting the bobbin winding. Otherwise the thread may become tangled and fail to wind the thread.

### 12 Press $\odot$ (Start/stop button) once.

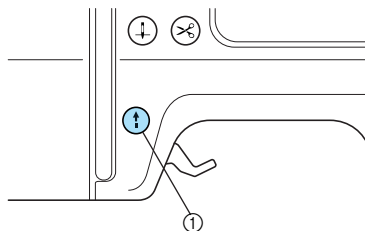

- ① Start/stop button

- ▶ The bobbin starts winding and "Winding bobbin thread..." is displayed on the LCD screen.

### Note

- Do not get away from the machine while winding the bobbin. Make sure the bobbin thread is being wound correctly. If the bobbin thread is wound incorrectly, press  $\odot$  (Start/stop button) immediately to stop the bobbin winding.

### 13 When the bobbin winding stops or becomes slow, press $\odot$ (Start/stop button) once to stop the machine.

- ▶ The bobbin winding will stop.

### CAUTION

- When the bobbin winding stops or becomes slow, stop the machine. Otherwise, the machine may be damaged.

- 14** Cut the thread with scissors, slide the bobbin winder shaft to the left, and then remove the bobbin from the shaft.

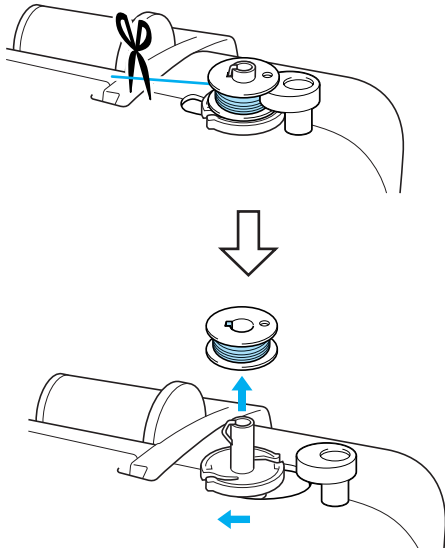

### Memo

- If the bobbin winder shaft is set to the right side, the needle will not move. (Embroidering is impossible.)
- When the machine is started or the handwheel is turned after winding the bobbin, the machine will make a clicking sound; this is not a malfunction.

- When the thread became tangled under the bobbin winder seat.

If the bobbin winding starts when the thread is not passed under the pretension disk of the bobbin-winding thread guide correctly, the thread may become tangled under the bobbin winder seat. In such a case, wind off the thread according to the following procedure.

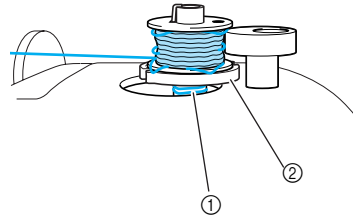

- ① Thread
- ② Bobbin winder seat

### CAUTION

- Do not remove the bobbin winder seat even if the thread become tangled under the bobbin winder seat. It may result in injuries.
- Do not remove the screw of the bobbin winder presser, otherwise the machine may be damaged; you cannot wind off the thread by removing the screw.

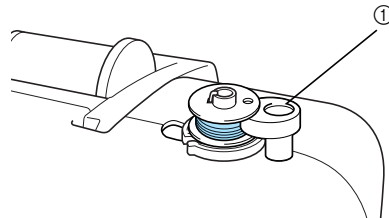

- ① Screw of the bobbin winder presser

- 1** If the thread become tangled under the bobbin winder seat, press **⏻** (Start/stop button) once to stop the bobbin winding.

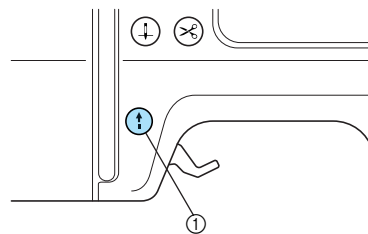

- ① Start/stop button

- 2 Cut the thread with scissors beside the bobbin-winding thread guide.

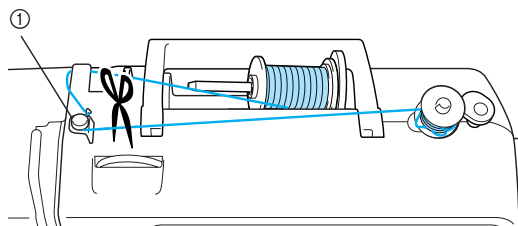

① Bobbin-winding thread guide

- 3 Slide the bobbin winder shaft to the left, and then remove the bobbin from the shaft.

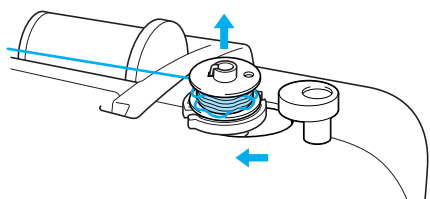

- 4 Hold the thread end with your left hand, and wind off the thread clockwise near the bobbin with your right hand as shown below.

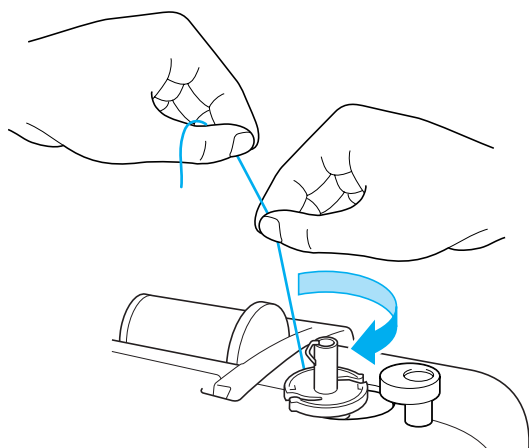

- 5 Wind the bobbin again.



### Note

- Make sure that the thread passes under the pretension disk of the bobbin-winding thread guide correctly (page 31).

## Installing the bobbin

Install the bobbin wound with thread.



### CAUTION

- Use a bobbin that has been correctly wound with thread, otherwise the needle may break or the thread tension will be incorrect.

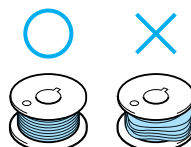

- The included bobbin was designed specifically for this machine. If bobbins from other models are used, the machine will not operate correctly. Use only the included bobbin or bobbins of the same type (part code: SA156, SFB (XA5539-151)).

Actual size

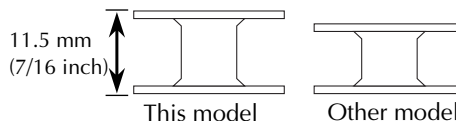

### Memo

- The order that the bobbin thread should be passed through the bobbin case is indicated by marks that surround the bobbin case.

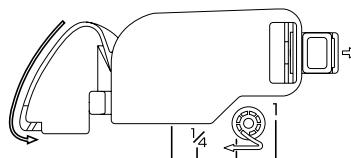

- 1 Press  $\oplus$  (Needle position button) once or twice to raise the needle, and then raise the presser foot lever.

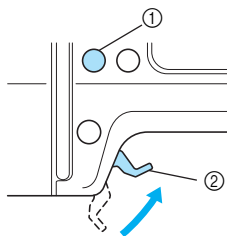

- ① Needle position button  
② Presser foot lever

- 2 Turn off the machine.

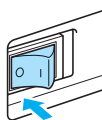

- 3 Slide the bobbin cover latch to the right.

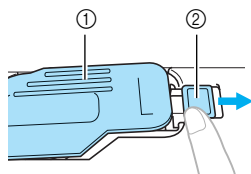

- ① Bobbin cover  
② Latch

▶ The bobbin cover opens.

- 4 Remove the bobbin cover.

- 5 Hold the bobbin with your right hand and hold the end of the thread with your left hand.

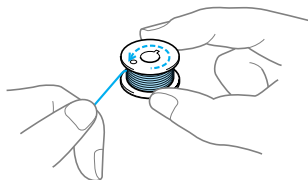

• Be careful not to drop the bobbin.

- 6 Insert the bobbin into the bobbin case with your right hand.

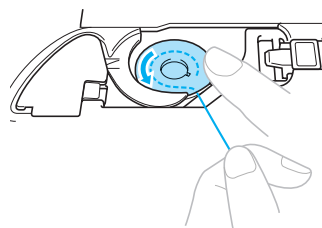

• Be sure to insert the bobbin correctly.

### ! CAUTION

- Be sure to insert the bobbin and depress it to the bottom with your finger. Otherwise, the thread may break or the thread tension will be incorrect.
- Be sure to thread the machine as indicated. Otherwise, the thread may break or the thread tension will be incorrect.

- 7 Lightly hold down the bobbin with your right hand, and then guide the thread as shown with your left hand.

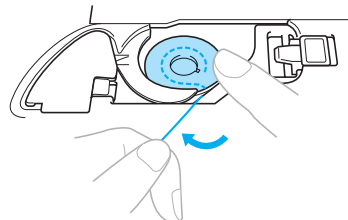

- 8 Pass the thread through the slot as shown, and then pull the thread out toward the front.

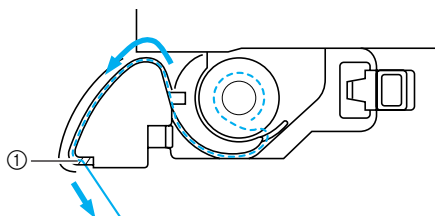

- ① Cutter

▶ The cutter cuts the thread.



### Note

- If the thread is not correctly inserted through the tension-adjusting spring of the bobbin case, it may cause incorrect thread tension (page 63).

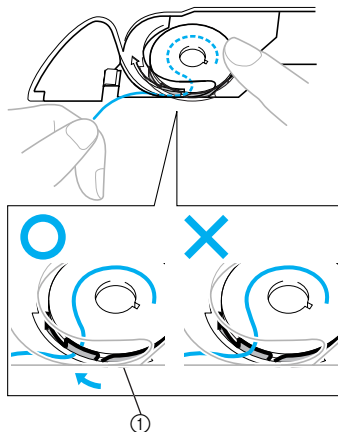

- ① Tension-adjusting spring

9

### Reattach the bobbin cover.

Insert the tab in the lower-left corner of the bobbin cover, and then lightly press down on the right side.

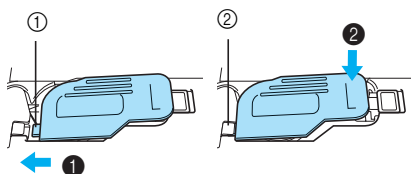

- ① Tab  
② Lower-left corner

- ▶ The bobbin threading is finished. You can begin embroidering without pulling up the bobbin thread.

Next, thread the upper thread. Continue with the procedure in "Upper Threading" (page 37).

# Upper Threading

This section describes how to position the spool for the upper thread, and then thread the needle.

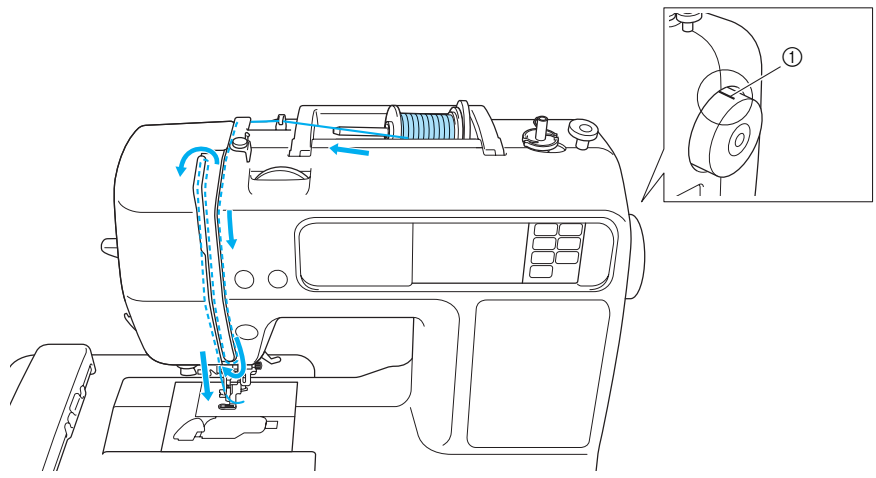

① Mark on handwheel

## ! CAUTION

- When threading the upper thread, carefully follow the instructions. If the upper threading is not correct, the thread may become tangled or the needle may bend or break.
- The needle threader can be used with a 75/11 through 100/16 home sewing machine needle. When using special thread such as transparent nylon thread or metallic thread, the needle threader cannot be used.
- Thread with a thickness of 130/120 or thicker cannot be used with the needle threader.
- If the needle threader cannot be used, refer to "Threading the needle manually (without using the needle threader)" (page 42).
- Never use a thread weight of 20 or lower.

## About the spool of thread

Information about the spools of thread is described below.

## ! CAUTION

- If the spool or the spool cap is not positioned correctly, the thread may become tangled around the spool pin or the needle may break.
- Three spool cap sizes are available, allowing you to choose a spool cap that best fits the size of spool being used. If the spool cap is too small for the spool being used, the thread may catch on the slit in the spool or the needle may break.

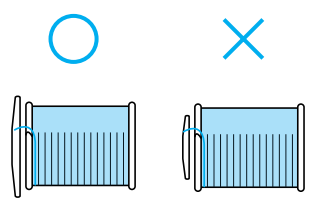

## Threading the upper thread

Set the spool of thread on the spool pin, and then thread the machine.



### Memo

- Use embroidery thread, or country embroidery thread intended for this machine to get attractive finishes. If you use other threads, the pattern may not turn out correctly.
- Before threading the upper thread, check the appropriate thread for the selected pattern. For details, refer to “Selecting Embroidery Patterns” (page 50).

## CAUTION

- When threading the upper thread, carefully follow the instructions. If the upper threading is not correct, the thread may become tangled or the needle may bend or break.

- 1 Turn on the machine.

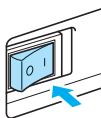

- 2 Raise the presser foot lever.

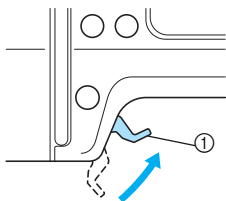

- 1 Presser foot lever

- ▶ The embroidery foot is raised.



### Memo

- If the embroidery foot is not raised, the machine cannot be threaded.

- 3 Press  $\oplus$  (Needle position button) once or twice to raise the needle.

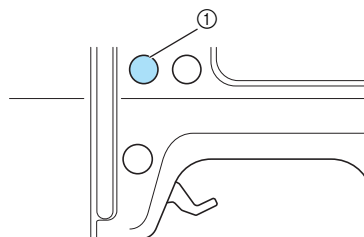

- 1 Needle position button



### Note

- The needle is correctly raised when the mark on the handwheel is at the top, as shown below. Check the handwheel and, if this mark is not at this position, press  $\oplus$  (Needle position button) until it is.

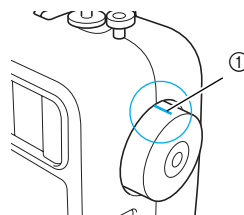

- 1 Mark on handwheel

- 4 Pick up the spool pin and remove the spool cap that is inserted onto the spool pin.

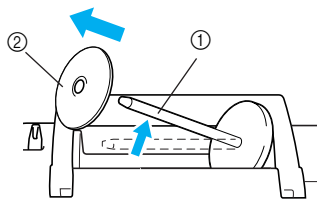

- 1 Spool pin
- 2 Spool cap

- 5 Place the spool of thread onto the spool pin. Slide the spool onto the pin so that the spool is horizontal and the thread unwinds to the front at the bottom.

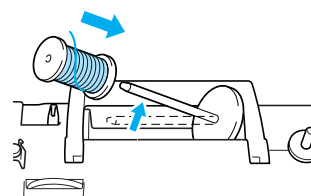



- 6** Slide the spool cap onto the spool pin and return the spool pin to its original position. Slide the spool cap as far as possible to the right as shown, with the rounded side on the left.

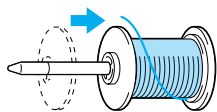

**CAUTION**

- If the spool or the spool cap is not positioned correctly, the thread may become tangled around the spool pin or the needle may break.

- 7** Pull the thread from the spool and pass the thread under the hook of the thread guide.

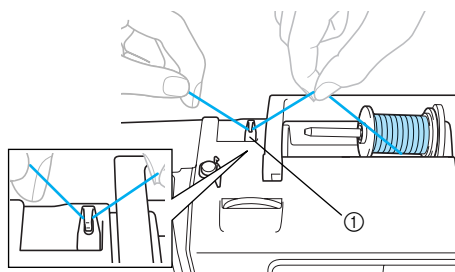

① Thread guide

- 8** Pass the thread behind the thread guide cover and to the front.

While holding the thread near the spool with your right hand, pull the thread with your left hand as shown below.

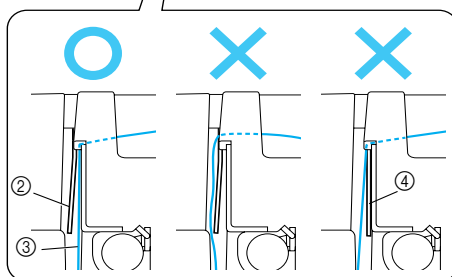
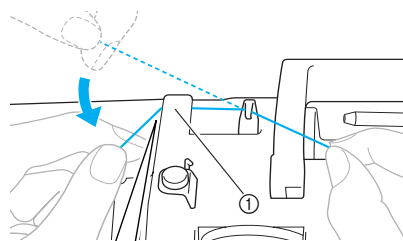

- ① Thread guide cover
- ② Thread guide spring
- ③ Thread
- ④ When the presser foot lever is lowered

**Note**

- When passing the thread behind the thread guide cover, be sure to use both hands. If you do not hold the thread with your right hand, the thread will be loose and you will not be able to secure the thread in the thread spring guide. It may cause incorrect thread tension.
- Make sure that the presser foot lever is raised before passing the thread behind the thread guide cover. If the presser foot lever is lowered, the thread guide spring is shut and you cannot hang the thread on the thread guide spring correctly.

- 9** Pass the thread through the guides in the order shown below.

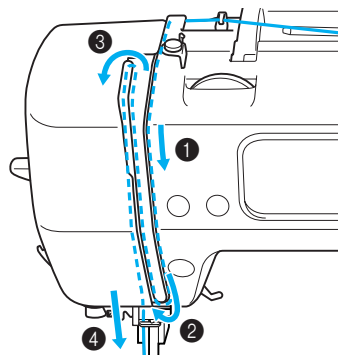

- 10** Make sure that the thread is passed into the thread take-up lever as shown below.

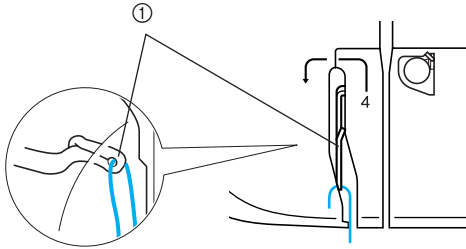

① Thread take-up lever



### Memo

- If the needle is not raised, you cannot pass the thread into the thread take-up lever. Be sure to press the needle position button to raise the needle before passing the thread into the thread take-up lever.

- 11** Pass the thread behind the needle bar thread guide.

The thread can easily be passed behind the needle bar thread guide by holding the thread in your left hand, then feeding the thread with your right hand, as shown.

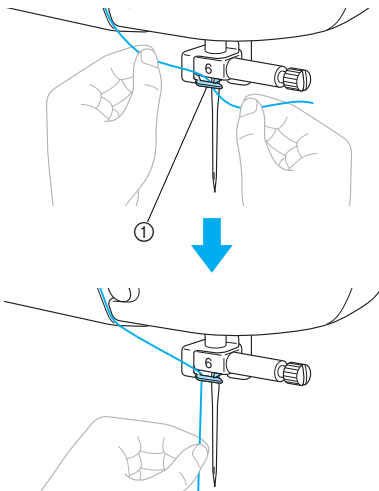

① Needle bar thread guide

- 12** Lower the presser foot lever to lower the embroidery foot.

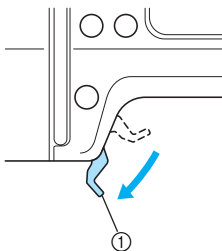

① Presser foot lever

- 13** Pull the end of the thread, which has been passed through the needle bar thread guide, to the left, then pass the thread through the notch of the thread guide (①), and then firmly pull the thread from the front and insert it into the slit of the thread guide disk marked "7" all the way (②).

Make sure that the thread passes the notch of the thread guide.

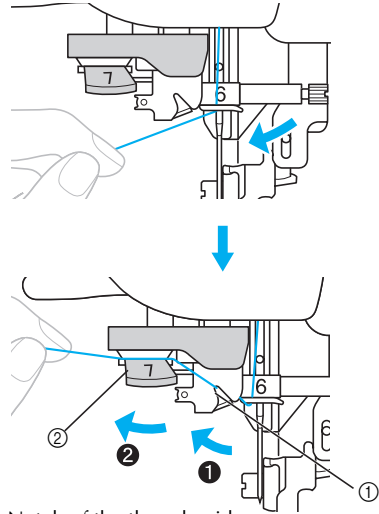

① Notch of the thread guide  
② Thread guide disk

- 14** Cut the thread with the cutter on the left side of the machine.

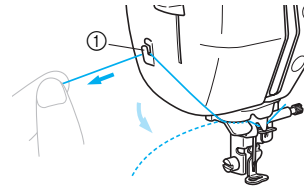

① Thread cutter

- 15** Lower the needle threader lever on the left side of the machine as much as possible to make the hook turn.

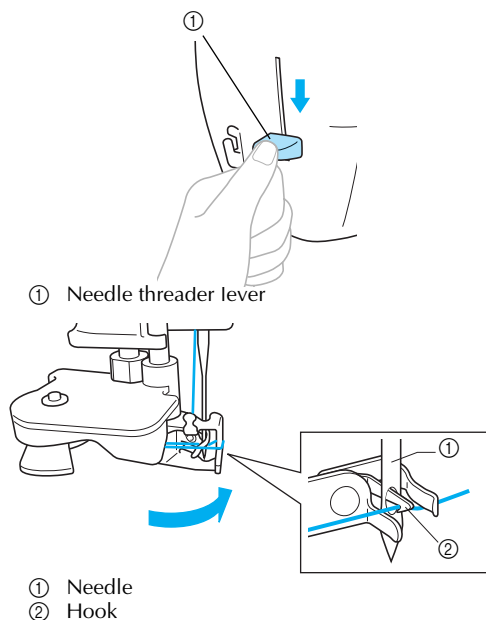

### Note

- If the needle threader lever is not lowered as much as possible, the hook will not turn fully as shown below and the thread will not pass through the eye of the needle. In such a case, start from **13** again.

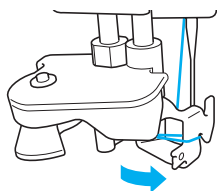

- If the needle is not raised, the needle threader cannot thread the needle. Be sure to press **+** (Needle position button) to raise the needle before using the needle threader. For details, refer to step **3** of "Threading the upper thread" (page 38).

- 16** Raise the needle threader lever slowly.

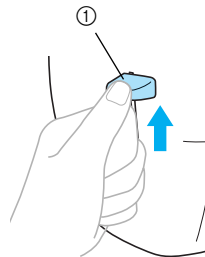

- ① Needle threader lever

- 17** Raise the presser foot lever, and carefully pull the loop of the thread through the eye of the needle to pull out the end of the thread.

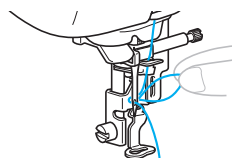

### ! CAUTION

- Do not touch a button. Do not touch the start/stop button or needle position button. If one of the buttons is accidentally pressed, the machine will move and your finger may be pricked with the needle or the needle may break.
- When pulling out the thread, do not pull it with extreme force, otherwise the needle may bend or break.

- 18** Pass the end of the thread through the embroidery foot hole.

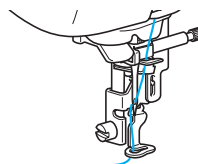

- ▶ The upper threading is finished.

### ■ Threading the needle manually (without using the needle threader)

When using specialty thread, such as transparent nylon thread which cannot be used with the needle threader, thread the needle as described below.

① Thread the machine to the needle bar thread guide according to steps ① through ① on "Threading the upper thread" (page 38).

② Lower the presser foot lever.

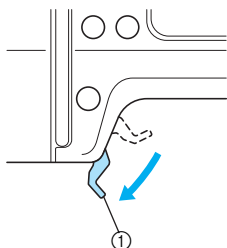

① Presser foot lever

③ Pass the thread through the eye of the needle from front to back.

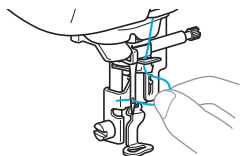

### ! CAUTION

- Do not touch the start/stop button or needle position button. If one of the buttons is accidentally pressed, the machine will move and your finger may be pricked with the needle or the needle may break.

④ Raise the presser foot lever, pass the end of the thread through the embroidery foot hole.

## Preparing the Fabric

After attaching a stabilizer material to the embroidery fabric, it is stretched on an embroidery frame.

### Attaching a stabilizer material to the fabric

Attach a stabilizer material for embroidery to the fabric to prevent poor quality embroidery designs.

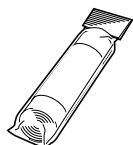

#### Memo

- We recommend the optional stabilizer material for embroidery. Use a water soluble sheet on thin materials like organdy and fabrics with a nap like towels. To obtain optional accessories or parts, visit [<http://www.brother.com/>], or [<http://www.brothermall.com>] (in USA).

### CAUTION

- Always use stabilizer material for embroidery projects. The needle may break or bend if you embroider without using a stabilizer material for thin fabrics or stretch fabrics. Furthermore, the pattern may not turn out correctly.

- 1 Prepare stabilizer material that is larger than the embroidery frame being used.

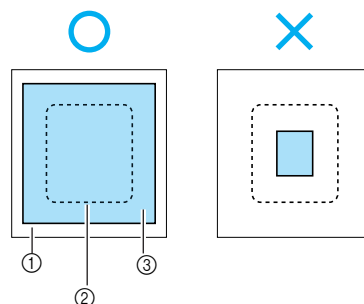

- ① Fabric
- ② Size of embroidery frame
- ③ Stabilizer material

- 2 If you are using stabilizers with adhesive, place the adhesive surface of the stabilizer material against the wrong side of the fabric, and iron it with a steam iron.

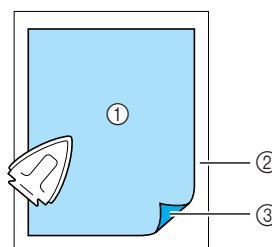

- ① Stabilizer material
- ② Fabric (wrong side)
- ③ Attached surface

- When it cannot be ironed or placed in the hoop

For fabrics, such as towels, which cannot be ironed or for embroidering in places where ironing is difficult, place the stabilizer material under the fabric, and stretch the fabric in the embroidery frame without attaching the stabilizer.

## Setting the fabric in the embroidery frame

The fabric is stretched in the embroidery frame. If the fabric is loose, the quality of the embroidery pattern may be poor. Put the fabric in the frame without slack following the steps below. Have a fabric with a stabilizer material attached and the embroidery frame (medium, small or large) ready.

### ■ Embroidery frame (medium)

Patterns with a height of up to 10 cm (4 inches) and a width of up to 10 cm (4 inches) can be embroidered.

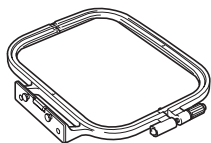

### ■ Embroidery frame (small) [option]

Patterns with a height of up to 2 cm (1 inch) and a width of up to 6 cm (2-1/2 inches) can be embroidered. This is used for letters and other small embroidery.

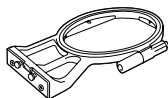

### Memo

- There are patterns for which embroidery frame (small) cannot be used.

### ■ Embroidery frame (large) [option]

Embroidery can be done in an area with a height of up to 17 cm (6-7/10 inch) and a width of up to 10 cm (4 inch). This is used to embroider multiple patterns without changing the fabric position in the frame.

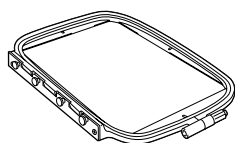

## ! CAUTION

- Use the embroidery frame that matches the size of the pattern being embroidered. Otherwise, the embroidery frame may be hit by the embroidery foot and cause injury or needle breakage.

- 1 Loosen the embroidery frame adjustment screw and remove the inner and outer frames, placing the outer frame on a flat surface. Separate the inner and outer frame by removing inner frame upward.

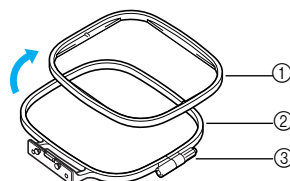

- ① Inner frame
- ② Outer frame
- ③ Adjustment screw

- 2 Place the fabric with the stabilizer material on top of the outer frame.

Have the right side of the cloth up.

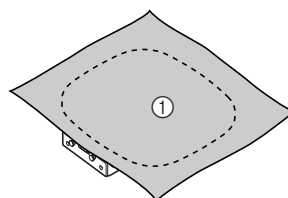

- ① Right side

- 3 Press the inner frame in from the top of the fabric.

Line up  $\triangle$  on the inner frame and  $\nabla$  on outer frame.

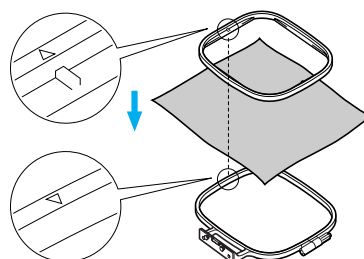

- 4 Tighten the adjustment screw by hand just enough to secure the fabric.

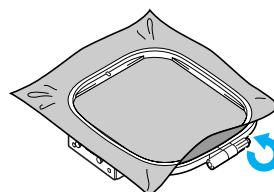

- 5** Gently remove the fabric from the frame without loosening the adjustment screw.

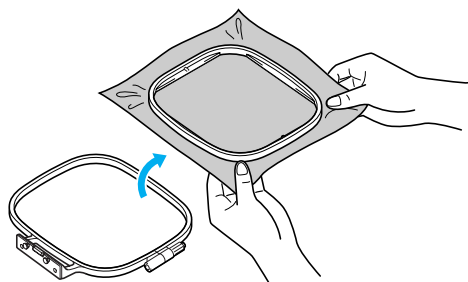

**Memo**

- This precautionary step will help reduce pattern distortion while embroidering.

- 6** Press the inner frame in from the top of the fabric again, lining up  $\triangle$  on the inner frame and  $\nabla$  on outer frame.

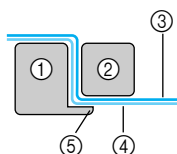
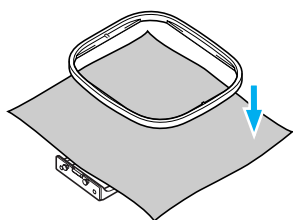

- ① Outer frame
- ② Inner frame
- ③ Fabric (right side)
- ④ Stabilizer material
- ⑤ Ledge of outer frame

- Press down firmly until the inner frame is securely pressed against the ledge of the outer frame.

- 7** Tighten the adjustment screw while removing any slack in the fabric by hand. The goal is to have a drum-like sound when the stretched fabric is struck lightly.

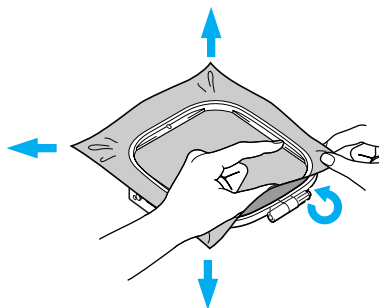

**Using embroidery sheets**

If the embroidery sheet attached to the embroidery frame is used, the pattern can be embroidered in exactly the right position on the fabric.

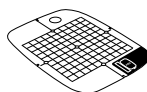

Embroidery sheet (medium)



Embroidery sheet (small) [option]

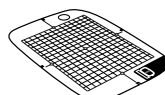

Embroidery sheet (large) [option]

- 1** Make a mark with a chalk pen at the center of the position for the pattern to be embroidered.

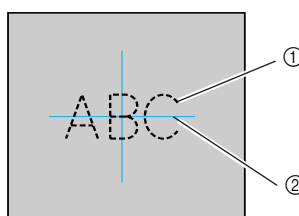

- ① Embroidery pattern
- ② Mark

## 2 Place the embroidery sheet on the inner frame.

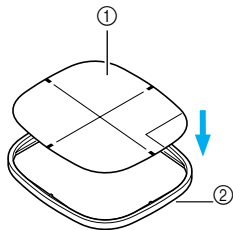

- ① Embroidery sheet
- ② Inner frame

## 3 Line the mark on the fabric up with the base line on the embroidery sheet.

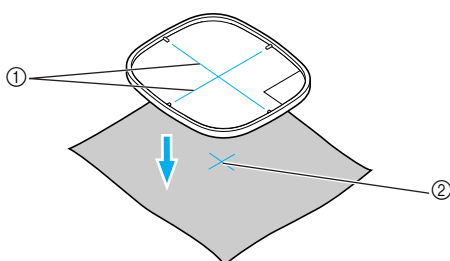

- ① Base line
- ② Mark

## 4 Place the inner frame with the fabric on the outer frame and stretch the fabric.

- For details, refer to page 44.

## 5 Remove the embroidery sheet.

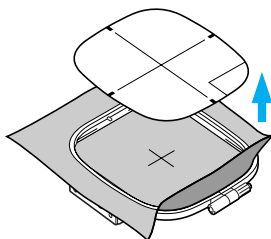

## Embroidery on fabrics that cannot be stretched on an embroidery frame

When small pieces of fabric that cannot be stretched on an embroidery frame or thin pieces like ribbon are being embroidered, use stabilizer material as a base to stretch on the frame. We recommend stabilizer material for all embroidery.

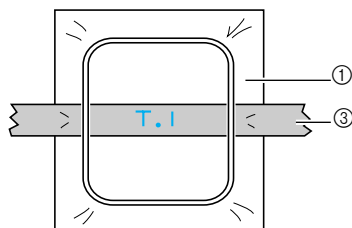
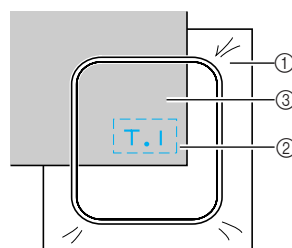
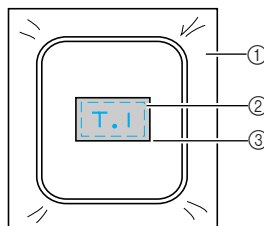

- ① Stabilizer material
- ② Tack or spray glue
- ③ Fabric

After completing the embroidery, remove the stabilizer material carefully.



## Attaching the Embroidery Frame

This section describes how to attach the embroidery frame.

### Attaching the embroidery frame

**1** Wind the embroidery bobbin thread onto the bobbin and set it into the bobbin case.

- For details, refer to "Winding/Installing the Bobbin" (page 29).

**2** Raise the presser foot lever.

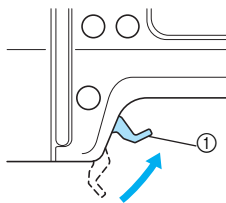

① Presser foot lever

**3** Press  (Needle position button) once or twice to raise the needle.

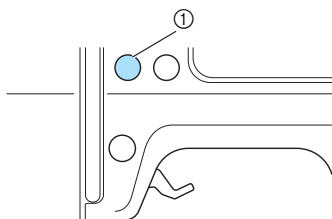

① Needle position button

**4** Pass the embroidery frame under the presser foot while raising the presser foot lever even further.

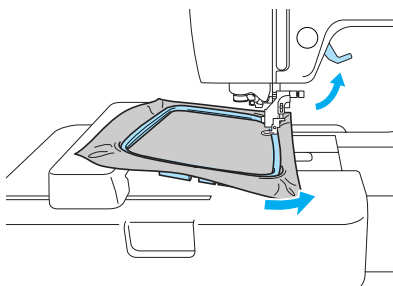

### CAUTION

- Do not touch the start/stop button or needle position button. If one of the buttons is accidentally pressed, the machine will move and your finger may be pricked with the needle or the needle may break.

**5** Firmly insert the embroidery frame guide into the embroidery carriage frame holder from the top.

Line up the embroidery frame guide tabs and the embroidery carriage frame holder slots and push in until it clicks and stops.

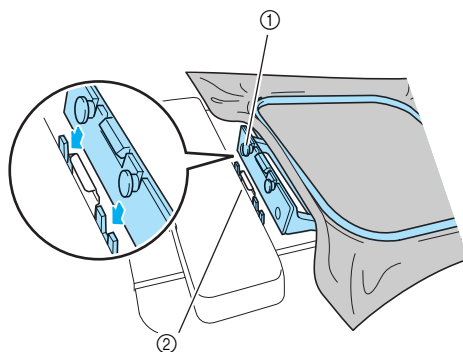

- ① Embroidery frame guide tabs
- ② Embroidery carriage frame holder slots

► The embroidery unit is attached.

### Note

- Be sure to insert both pins. If only the forward or the back pin is inserted, the pattern may not turn out correctly.

### CAUTION

- Correctly set the embroidery frame into the embroidery frame holder. Otherwise, the embroidery foot may hit the embroidery frame, resulting in injury.

## Removing the embroidery frame

Make sure that the machine is completely stopped and follow the instructions below.

- 1 Raise the presser foot lever.

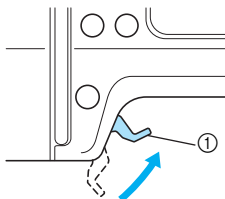

① Presser foot lever

- 2 Press  (Needle position button) once or twice to raise the needle.

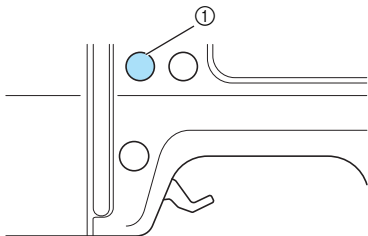

① Needle position button

- 3 Press the part of the embroidery frame holder to the left side as shown in the figure below, and raise the embroidery frame.

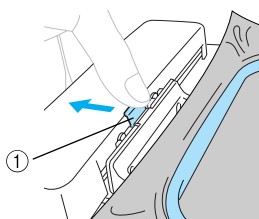

① Press here to remove.

- ▶ The embroidery frame will separate from the embroidery frame holder.

- 4 Pass the embroidery frame under the presser foot while raising the presser foot lever even further.

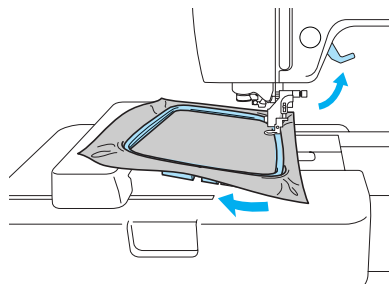

- 5 Remove the embroidery frame.

### CAUTION

- Do not touch the start/stop button or needle position button. If one of the buttons is accidentally pressed, the machine will move and your finger may be pricked with the needle or the needle may break.



## **EMBROIDERY**

The steps for embroidering are described in this chapter.

<b>Selecting Embroidery Patterns.....</b>	<b>50</b>
<b>Embroidering.....</b>	<b>57</b>
<b>Editing and Saving Patterns .....</b>	<b>61</b>
<b>Using the Memory Function.....</b>	<b>69</b>

## Selecting Embroidery Patterns

This section provides details on the various types of embroidery patterns available and the procedure for selecting a pattern.

### Copyright information

The patterns saved in the machine and embroidery cards are intended for private use only. Any public or commercial use of copyrighted patterns is an infringement of copyright law and is strictly prohibited.

### Embroidery pattern types



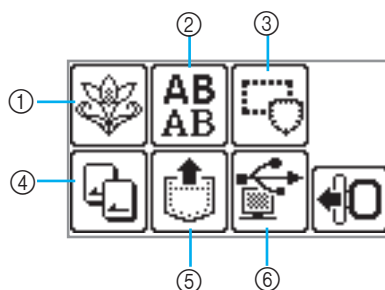

An embroidery pattern can be selected from the following types available.



- ① **Embroidery patterns**  
There are total 70 patterns. The patterns are completed by changing the upper thread according to the instructions displayed on the screen.  
For details, refer to "Selecting an embroidery pattern"(page 54).
- ② **Alphanumeric character patterns**  
There are 5 types of characters: upper case/lower case/numbers/symbols/European characters.  
For details, refer to "Selecting alphanumeric characters" (page 53).
- ③ **Frame patterns**  
10 shapes, such as squares and circles, can be combined with 12 stitch types.  
For details, refer to "Selecting a frame pattern" (page 55).
- ④ **Embroidery card**  
Press when selecting patterns from an embroidery card.  
For details, refer to "Using an embroidery card" (page 55).
- ⑤ **Patterns saved in the machine's memory**  
Press when retrieving patterns from the machine's memory.  
For details, refer to "Saving patterns" (page 70).
- ⑥ **Patterns retrieved from the computer**  
Patterns retrieved from a computer can be embroidered.  
For details, refer to "Retrieving embroidery patterns from the computer" (page 71).

## Setting for embroidering

### □ Setting the display while embroidering

Press  (Settings key) and then  (Next page key). Then, select the item by pressing  .

NAME OF COLOR: Typical color name

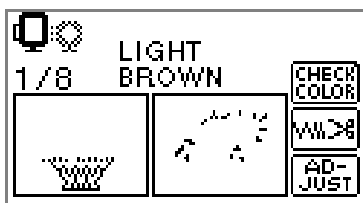
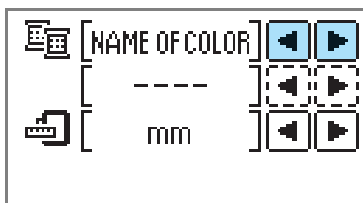

TIME: Time required for embroidering

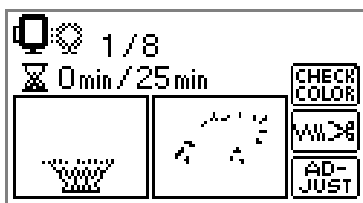
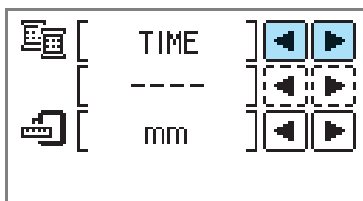

NEEDLE COUNT: Needle progress number

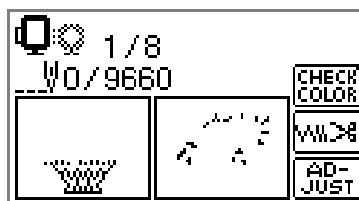
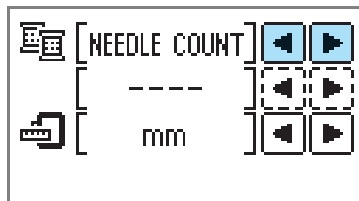

#123: Thread color number

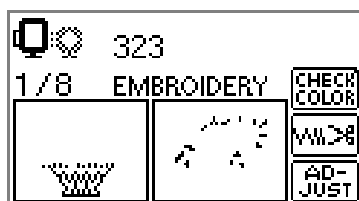
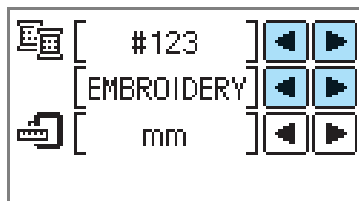

Select from the following thread color number sets (The display above is an example when EMBROIDERY (POLYESTER) THREAD# is selected.)

- EMBROIDERY (POLYESTER) THREAD#
- COUNTRY (COTTON) THREAD#
- MADEIRA POLY THREAD#
- MADEIRA RAYON THREAD#
- SULKY THREAD#
- ROBISON-ANTON POLY THREAD#

DISPLAY UNIT

The measurement units that are displayed can be selected. [mm/inch]

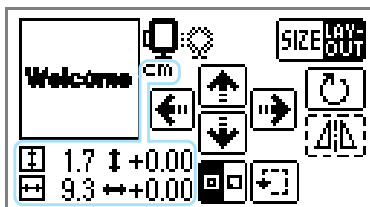
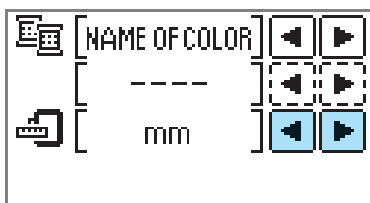

■ LCD button

Example: Selecting alphanumeric characters



**CHECK** When a specific pattern is selected, press this key and then, press **▶** to switch the display. The settings such as the specified alphanumeric character string and color are confirmed.



**MM>8** Press this key to change the thread settings.

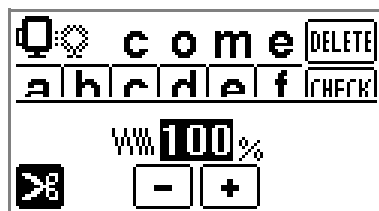

**✂** Press this key to select or cancel programmed thread cutting. When programmed thread cutting is set, the thread is cut automatically after reinforcement.

**MM...%** Press **+** or **-** to change the thread density (characters and frame patterns only).

**AD-JUST** Press this key to adjust the pattern.



**MULTI-COLOR** Press this key when you want to change the color, character by character in character embroidery. Since the machine stops at the end of each character, the upper thread is changed as you embroider. Press this key again to cancel multi-color.



**MM>8** The needle progresses one color or one stitch (if pressed continuously, 9 stitches to 30 stitches) at a time and changes the position for starting the embroidery. This is used when a specific color is not embroidered or when restarting the machine after power has been turned off in the middle of the operation.



- Back one color
- Forward one color
- Back one stitch
- Forward one stitch

• For details, refer to "Resewing" (page 66).

The position of the pattern within the embroidery frame can be checked, and the size and angle can be changed. For details, refer to "Adjusting the layout and the size" (page 61).

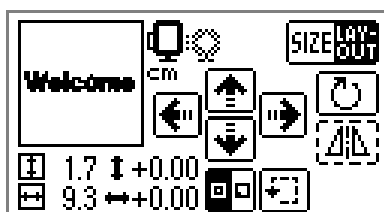

### Memo

- Keys that appear surrounded with a dotted line (ex. ) cannot be used.

#### Example: Selecting an embroidery pattern

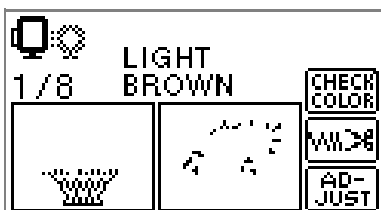

Press this key to check the order of multi color. Press to switch the display.

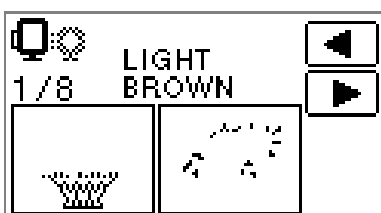

## Selecting alphanumeric characters

Specify the characters for embroidery.

### Memo

- When "The pattern is too large for the embroidery frame" is displayed, no more characters can be entered.
- Characters of different style (sans serif, serif and outline, etc.) cannot be combined.

#### 1 Select the alphanumeric characters.

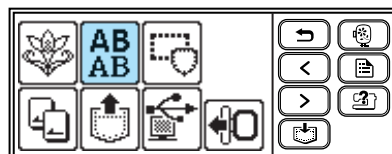

#### 2 Select the character style.

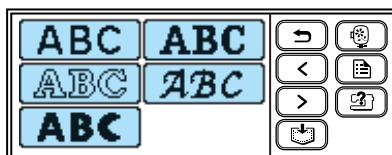

#### 3 Enter the characters.

### Memo

- If a wrong character is selected, press .
- To enter a space, press " \_ ".

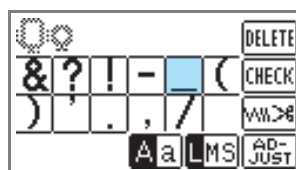

□ Example: Come on

- Switch between uppercase/lowercase
- Switch among large/medium/small sizes

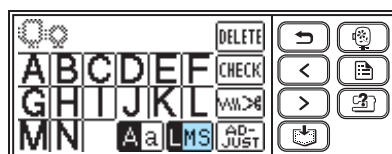

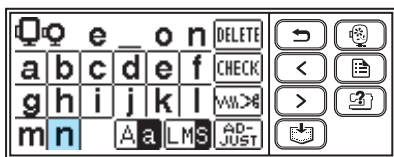
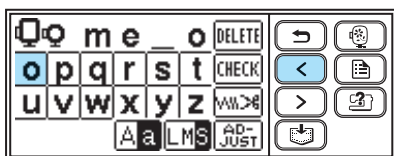
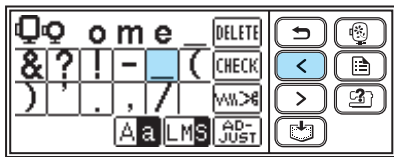
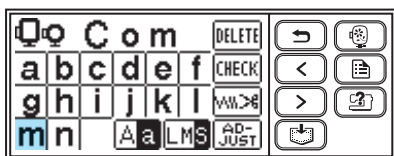
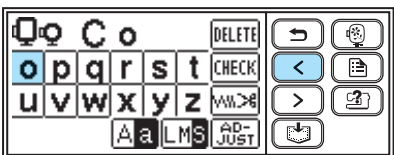
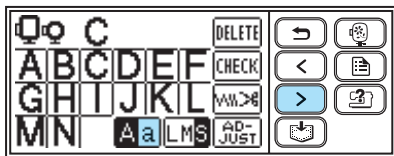
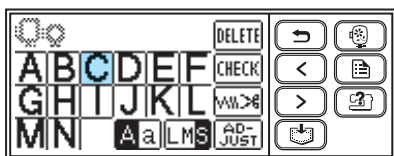

**Memo**

- The character pattern you created can be saved for later use. For details, refer to "Saving patterns" (page 70).

**Selecting an embroidery pattern**

There are 70 embroidery patterns, such as flowers and animals, saved in the machine's memory.



70 Embroidery patterns



**Memo**

- Refer to "Embroidery Pattern Color Change Table" in the Quick reference guide for samples of completed patterns and the thread used.

1

Press .

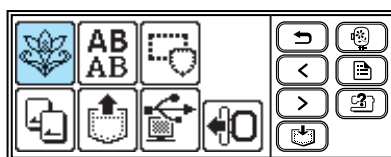

▶ The pattern selection screen is displayed.

2

**Select the pattern.**

Switch the screen using (Previous page key) and (Next page key).

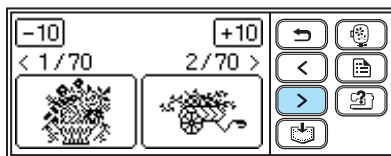

When is pressed, the display of patterns moves backward/forward 10 patterns.

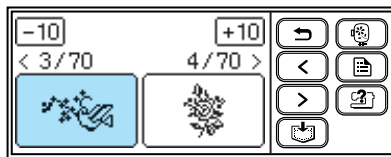
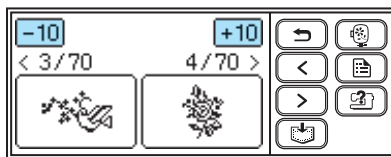

▶ When a pattern is selected, it can be embroidered.





## Selecting a frame pattern

10 shapes, such as squares and circles, can be combined with 12 stitch types.



### Memo

- Refer to "Frame patterns" in the Quick reference guide for frame pattern shapes and stitches.

1

Press

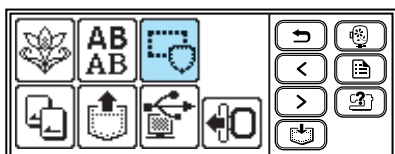

- ▶ The frame shape selection screen is displayed.

2

### Select the frame shape.

Switch the screen using (Previous page key) and (Next page key), and select from the 10 types.

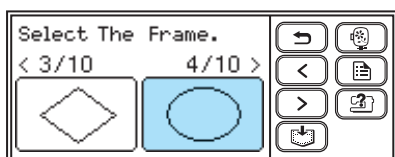
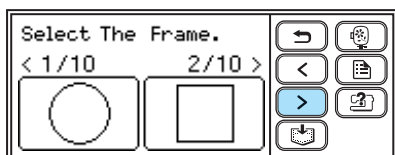

- ▶ The stitch selection screen is displayed.

3

### Select the stitch.

Switch the screen using (Previous page key) and (Next page key), and select from the 12 stitches.

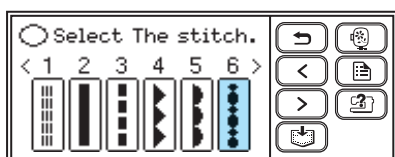

- ▶ When a stitch is selected, it can be embroidered.

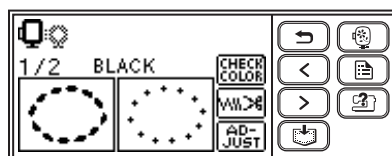

## Using an embroidery card

If an embroidery card is used, you can embroider patterns other than the patterns saved in the machine. There are various cards with different themes.



### Note

- Always turn off the machine to insert and remove embroidery cards.
- Insert the embroidery card into the embroidery card slot, facing it in the right direction.
- Do not put anything other than an embroidery card in the embroidery card slot.
- When embroidery cards are not in use, keep them in their storage cases.
- Use only embroidery cards manufactured for this machine. Using unauthorized cards may cause your machine to operate incorrectly.
- Embroidery cards purchased in foreign countries may not work with your machine.

1

### Turn off the machine.

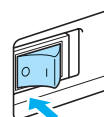

**2 Insert the embroidery card in the embroidery card slot on the right side of the machine.**

Face the arrow on the embroidery card toward you, and insert it in the direction of the arrow.

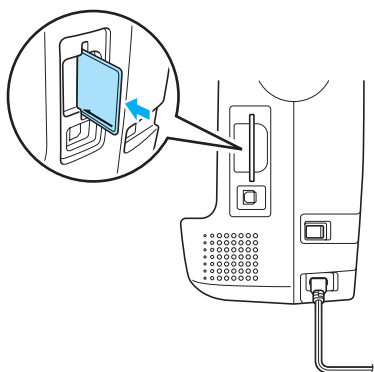

**3 Turn on the machine.**

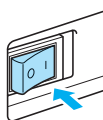

**4 Press  on the screen.**

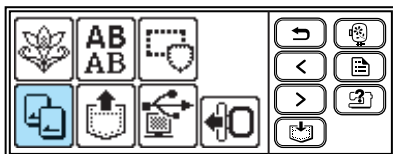

▶ This selection screen for the patterns saved in the card is displayed.

**5 Select a pattern.**  
The operation is the same as in "Selecting an embroidery pattern" (page 54).



# Embroidering

After the preparations are done, you can try embroidering. This section describes the steps for embroidering and appliquéing.



## Note

- Before embroidering, check that there is enough thread in the bobbin. If you continue embroidering without enough thread in the bobbin, the thread may tangle.
- When embroidering on large garments (especially jackets or other heavy fabrics), do not let the fabric hang over the table. Otherwise, the embroidery unit cannot move freely, and the pattern may not turn out as planned.

## Embroidering a pattern

Embroidery patterns are embroidered with a change of thread after each color.

### 1 Prepare embroidery thread of the color shown on the screen.

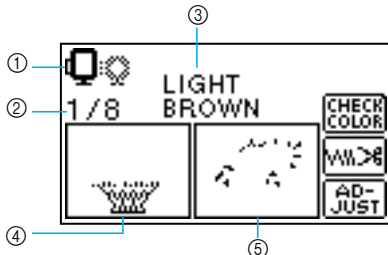

- ① Embroidery frames that can be used for embroidering
- ② Current color step/Number of colors in design
- ③ Current name of color
- ④ Current color part
- ⑤ Next color part

- The thread color number set displayed for the thread colors can be changed. Press  (Setting key), and then change the setting in the setting screen. For details, refer to "Setting for embroidering" (page 51).

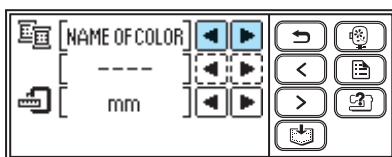
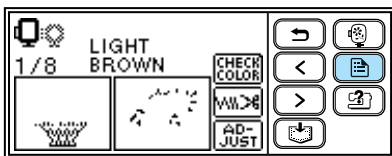

- Example: Embroidery thread number selected

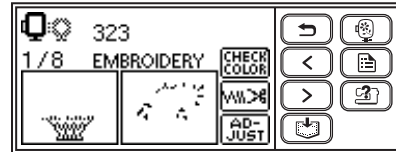

### 2 Set the embroidery thread, and thread the needle.

- Refer to "Threading the upper thread" (page 38).



## Note

- Before using the needle threader, be sure to lower the embroidery foot.

### 3 Pass the thread through the embroidery foot hole, and hold it lightly in your left hand.

Give the thread a little slack.

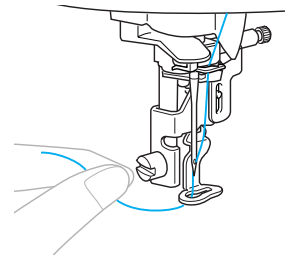

## CAUTION

- If the thread is pulled too tight, the needle may break or bend.
- Do not let hands or objects hit the carriage while embroidering. The pattern may misalign.

#### 4 Lower the presser foot lever.

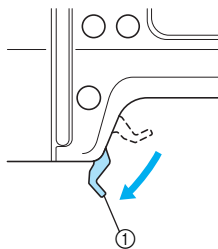

① Presser foot lever

#### 5 Press (Start/stop button).

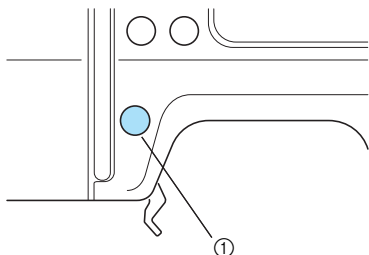

① Start/stop button



#### Note

- Do not leave objects in the range of motion of the embroidery frame. The frame may strike the object and cause a poor finish to the embroidery pattern.



#### CAUTION

- Use the embroidery frame that matches the size of the pattern being embroidered. Otherwise, the embroidery frame may be hit by the embroidery foot and cause injury or needle breakage.

#### 6 After progressing 5-6 stitches, press (Start/stop button) to stop the machine.

#### 7 Use scissors to cut the thread at the beginning of the stitching.

Cut the thread at the edge of the stitching.

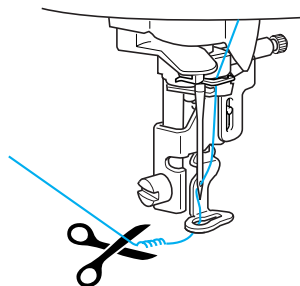

#### Note

- If the thread is left at the beginning of the stitching, it may be sewn over as you continue embroidering the pattern, making it very difficult to deal with the thread after the pattern is finished. Trim the thread at the beginning.

#### 8 Press (Start/stop button) again.

- ▶ The embroidery starts again and stops automatically with reinforcement after one color has been completed. When programmed thread cutting is set, the thread is cut automatically after reinforcement. In this case, go to step 10.

#### 9 Press (Thread cutter button) once.

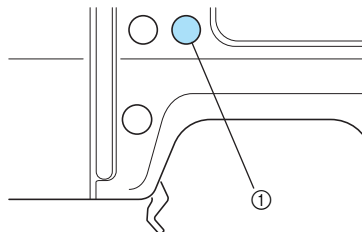

① Thread cutter button

- ▶ The needle is raised and the threads are cut.

#### 10 Raise the presser foot lever.

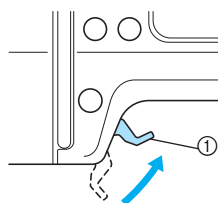

① Presser foot lever



#### Memo

- If the embroidery foot is not raised, the upper thread cannot be replaced.

## 11 Remove the upper thread.



### Note

- Be sure to raise the presser foot lever before removing the upper thread. If you remove the upper thread with the embroidery foot lowered, it may cause malfunction.

## 12 Set up embroidery thread for the next color, and repeat steps a through e.

- ▶ When the last color is embroidered, "Finished sewing." will appear on the display. Press **OK**, and the display will return to the initial screen.

## 13 Cut the excess thread.



### Memo

- For the programmed thread cutting setting, refer to "Setting for embroidering" (page 52).

## Appliquéing

Prepare the base fabric and the appliqué fabric (appliqué piece). Press **☰** (Settings key), and set the thread color display to NAME OF COLOR, so "APPLIQUE MATERIAL", "APPLIQUE POSITION" and "APPLIQUE" are displayed on the screen.

### 1 Select an appliqué pattern.

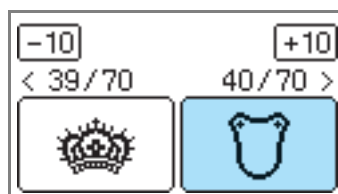

- ▶ "APPLIQUE MATERIAL" is displayed on the screen.

### 2 Apply iron-on stabilizer to the back of the appliqué piece fabric, and stretch it on the embroidery frame.

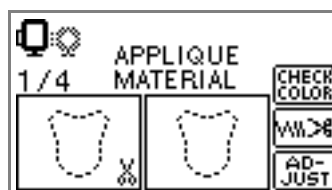

### 3 Lower the presser foot lever, and press **↑** (Start/stop button).

- ▶ The cut-out for the appliqué piece is sewn, and the machine stops.

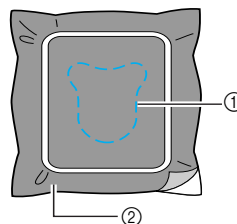

- ① Cut-out line
- ② Appliqué piece fabric

- ▶ "APPLIQUE POSITION" will be displayed on the screen.

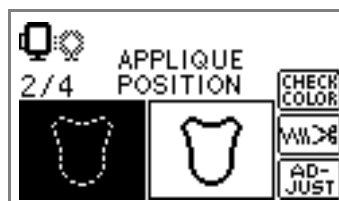

- 4** Remove the fabric from the embroidery frame, and cut it out along the cut-out line.

Cut carefully along the stitching and remove the thread.

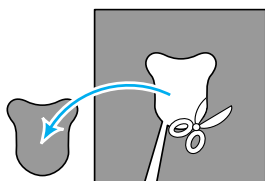

- If it is not cut right on the stitching, it will not be finished neatly.

- 5** Stretch the base fabric on the embroidery frame.

- 6** Set up the thread for appliquéing.

- 7** Lower the presser foot lever, and press **Ⓜ** (Start/stop button).

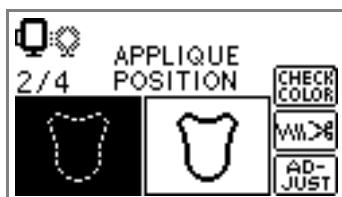

- ▶ The position for the appliqué is stitched, and the machine stops. "APPLIQUE" will be displayed on the screen.

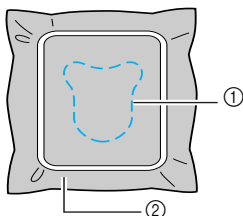

- ① Appliqué position  
② Base fabric

- 8** Apply a thin layer of fabric glue or spray adhesive to the back of the appliqué piece, and attach it in the appliqué position.

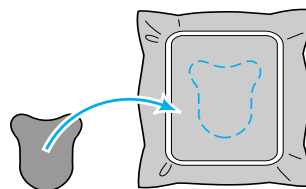

- 9** Lower the presser foot lever, and press **Ⓜ** (Start/stop button).



- ▶ The position for the appliqué is stitched, and the machine stops.

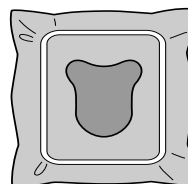

### Memo

- When "APPLIQUE MATERIAL", "APPLIQUE POSITION" and "APPLIQUE" are displayed, a specific color thread does not appear. Use a proper color thread to match the appliqué piece.

- 10** Follow the instructions on the screen, and change thread colors as you embroider.

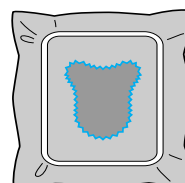
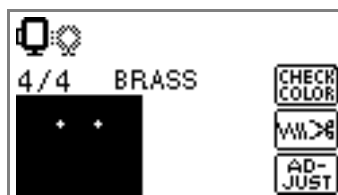

## Editing and Saving Patterns

This section describes ways to edit, adjust, reposition and memorize patterns.

### Adjusting the layout and the size

The pattern is normally positioned in the center of the embroidery frame. You can check the layout before starting embroidery and change the position and the size.



#### Memo

- Keys that appear surrounded with a dotted line (ex. ) cannot be used.

#### 1 After selecting the embroidery pattern, press .

- ▶ The embroidering screen is displayed.



#### 2 Press .

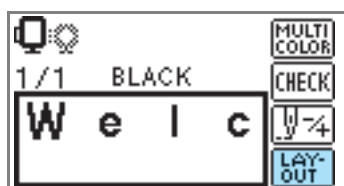

- ▶ The layout screen is displayed.

#### 3 Check and adjust the layout.

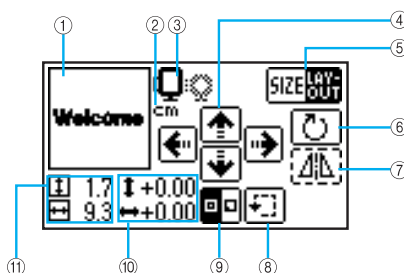

- ① Layout within the frame
- ② Display unit (cm/INCH)
- ③ Available embroidery frames
- ④ Change position keys
- ⑤ Size key/Layout key
- ⑥ Rotation key
- ⑦ Horizontal mirror image key
- ⑧ Trial key
- ⑨ Starting point key
- ⑩ Distance from the center
- ⑪ Embroidery size



#### Embroidery frame size

The size of embroidery frame that can be used is displayed. When the smaller mark is grayed out in the display, embroidery frame (small) cannot be used. These icons flash if the pattern was resized, the layout was adjusted, or the recommended embroidery frame size was changed.

#### ! CAUTION

- Use the embroidery frame that matches the size of the pattern being embroidered. Otherwise, the embroidery frame may be hit by the embroidery foot and cause injury or needle breakage.



### Size key

Increases/decreases the size of the pattern. Press **LAY-OUT** to return to the previous screen.



Decreases size



Returns to original size. When the pattern was moved with the change position keys, it returns to its original position.



Increases size



### Change position keys

Moves the embroidery position up, down, left and right.



### Memo

- If you change the size of the pattern or reverse it, the embroidery which have been moved will return to its initial position. Use the Change position keys after you have changed the size of the pattern or reversed it.
- The embroidery patterns you have edited or adjusted can be saved in the machine's memory. For details, refer to "Saving patterns" (page 70).



### Layout key

Press this key to move to rotation screen.

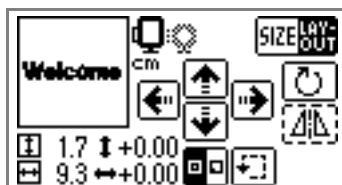

### Rotation key

Rotates the pattern 1 degree, 10 degrees or 90 degrees at a time.

Press **←** (Back key) to return to the previous screen.

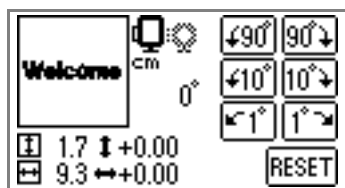

Rotates the pattern 90 degrees to the left



Rotates the pattern 90 degrees to the right



Rotates the pattern 10 degrees to the left



Rotates the pattern 10 degrees to the right



Rotates the pattern 1 degree to the left



Rotates the pattern 1 degree to the right



Returns the pattern to its original position



### Memo

- When the pattern is larger than 10cm (4 inches) x 10cm (4 inches), there may be a case that the pattern cannot be rotated.



### Horizontal mirror image key

Mirrors the pattern left and right.



### Memo

- Mirroring patterns is possible only for a embroidery pattern or a frame pattern.



### Starting point stitching key

Switches the stitching starting point between center and lower left of the design.

- Press **←** (Back key) to return to the previous screen.



### Trial key

Moves the frame to check the pattern position.

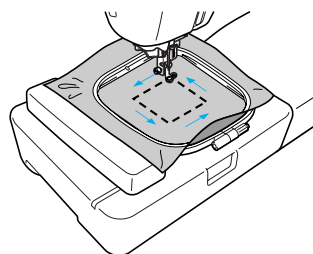





## CAUTION

- Never lower the needle when the embroidery frame is moving. The needle may break or bend.
- When you have revised the pattern, check the display of available embroidery frames and use an appropriate frame. If you use an embroidery frame not displayed as available for use, the embroidery foot may strike the frame and possibly cause injury.

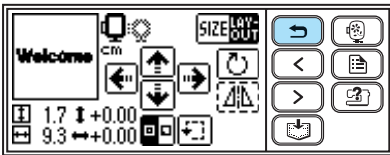
- 4 Press  (Back key) to return to the previous screen.



### Memo

- When the machine is turned off, the layout returns to the original setting.
- You can also check the pattern size and distance from the center by pressing  after beginning embroidering.
- The embroidery patterns you have edited or adjusted can be saved in the machine's memory. For details, refer to "Saving patterns" (page 70).

## Adjusting the upper thread tension

If embroidery fails, it is difficult to undo the thread and the fabric may be damaged. Before embroidering, use a scrap of the same fabric to check the adjustment of the thread tension, etc.

The upper thread tension is changed using the thread tension dial.

When doing machine embroidery, the tension dial should be set somewhere between 2 to 6.

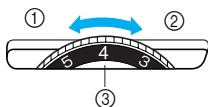

- ① Loose (Decrease thread tension)
- ② Tight (Increase thread tension)
- ③ Upper thread tension dial



### Memo

- If the stitches appear loose, turn the tension up one notch and resew.

#### Correct thread tension

The thread tension is correct when upper thread slightly appears on the wrong side of fabric.



- ① Right side of fabric
- ② Wrong side of fabric

#### Upper thread is too tight

The lower thread will be visible on the right side of fabric. If this occurs, decrease the upper thread tension.



- ① Right side of fabric
- ② Wrong side of fabric

#### Upper thread is too loose

The upper thread has slack. If this occurs, increase the upper thread tension.



- ① Right side of fabric
- ② Wrong side of fabric



### Note

- If the upper thread is not threaded correctly or the bobbin is not installed correctly, it may not be possible to set the correct thread tension. If the correct thread tension cannot be achieved, rethread the upper thread and insert the bobbin correctly.
- If the tension dial is set extremely low, the machine may stop stitching during embroidering. This is not a sign that anything's broken. Simply increase the tension slightly to continue embroidering.

## Adjusting the bobbin thread tension

The bobbin case installed in this machine can be adjusted, if necessary, to accommodate the bobbin tension for embroidering.

Using a small slotted screwdriver, turn the slotted-head (-) screw to adjust the bobbin case tension.

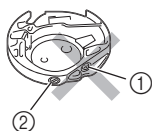

- ① Do not turn a phillips screw (+).
- ② Adjust with a screwdriver (small).

### ■ Correct thread tension

The thread tension is correct when upper thread slightly appears on the wrong side of fabric.



- ① Right side of fabric
- ② Wrong side of fabric

### ■ Bobbin thread is too tight

Upper thread on the right side of fabric seems to be lifting/looping and bobbin thread is not seen on the wrong side of fabric.



- ① Right side of fabric
- ② Wrong side of fabric

If this occurs, turn the slotted-head screw (-) counterclockwise being careful not to over-loosen the screw, approximately 30-45 degrees to decrease bobbin tension.

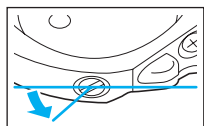

### ■ Bobbin thread is too loose

Bobbin thread appears slightly on the right side of fabric.



- ① Right side of fabric
- ② Wrong side of fabric

If this occurs, turn the slotted-head screw (-) clockwise, being careful not to over-tighten the screw, approximately 30-45 degrees to increase bobbin tension.

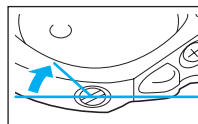

### ! CAUTION

- When adjusting the bobbin case, be sure to remove the bobbin from the bobbin case.
- **DO NOT** adjust the position of the Phillips (+) screw on the bobbin case as this may result in damage to the bobbin case, rendering it unusable.
- If the slotted-head screw (-) is difficult to turn, do not use force. Turning the screw too much or providing force in either (rotational) direction may cause damage to the bobbin case. Should damage occur, the bobbin case may not maintain proper tension.



## Connecting character patterns

If the character pattern is too long to fit in the embroidery frame, follow the steps below.

Example: Connecting "ABC" with "DEF"

1 Enter "ABC" and press .



2 Press  to turn off the programmed thread cutting ().



3 Press  (Back key).

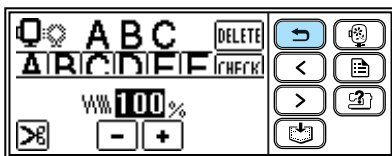

4 Press .



5 Press .

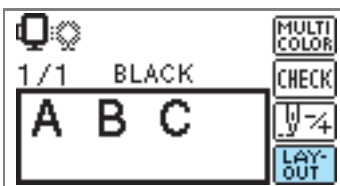

6 Press  to turn it to .

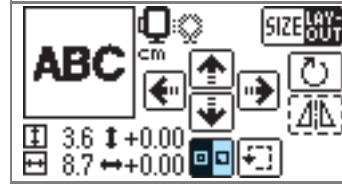

▶ The stitching starting point is set to lower left of the design.

7 Lower the embroidery foot, and then press  (Start/stop switch) to begin embroidering.

8 When embroidering is finished, trim the thread leaving the end of the thread longer than usual. Then reset the fabric in the embroidery frame, in a position where you can embroider "DEF".

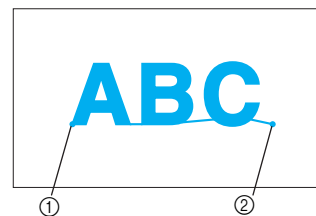



① Embroidery start position  
② Embroidery end position

9 Enter "DEF" and press .



10 Press .



11 Press  to turn it to .

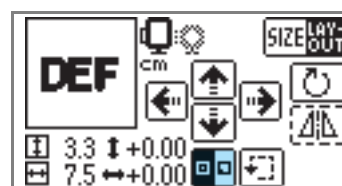

▶ The stitching starting point is set to lower left of the design.

- 12 Use  (change position keys) to move the needle to the embroidery end position of "ABC".

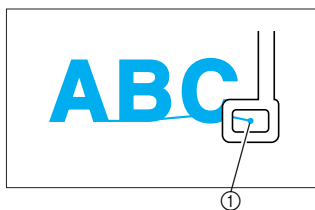

① Embroidery end position

- 13 Lower the embroidery foot, and then press  (Start/Stop button) to embroider "DEF".



- 14 When you have finished embroidering, cut the thread.

## Resewing

When the wrong upper thread color has been sewn, it can be re sewn with the correct color.

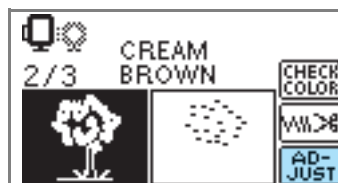

- 1 Press  (Start/stop button) to stop the machine.

- 2 Press .



- 3 Press .



- 4 Press  (Back one color) to return to the beginning of the mistaken color. Press  one more time to go to previous color.



- 5 Set up the correct color for the upper thread.

- 6 Press  (Start/stop button) to continue the design.

## Thread runs out partway through a design

When the upper thread or the bobbin thread runs out while embroidering, the machine stops. Move the needle back about 10 stitches and resume embroidering.



### Memo

- When the bobbin thread runs out, cut the threads and remove the embroidery frame before replacing the bobbin thread.

#### 1 Set the upper thread or bobbin thread.

- 2 Press .

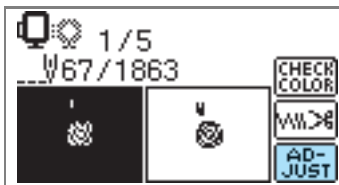

### Memo

- If the needle count is not displayed, display the needle count on the screen. For details, refer to "Stopping while embroidering" (page 67).

- 3 Press .

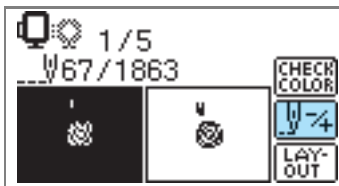

- 4 Press (Back one stitch) to move the needle back about 10 stitches.

(Forward one stitch) increases the stitch number.

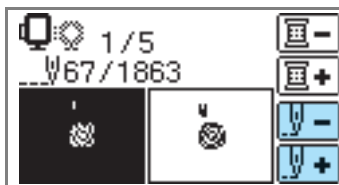

- 5 Restart the embroidery.

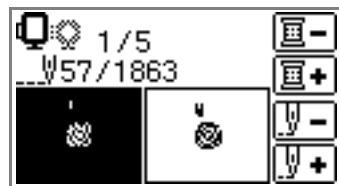

## Stopping while embroidering

If the embroidery is stopped before it is complete, check the current needle count and layout before turning off the machine.



### Memo

- When the machine is turned off, the embroidery size and layout return to the original setting. If you have changed the layout, you need to adjust it again.

- 1 Press (Start/stop button) to stop the machine.

- 2 Check the current needle count on the screen and make a note of it.



If the needle count is not displayed, press

(Settings key), and then use to display the following screen.

Press to return to the previous screen.

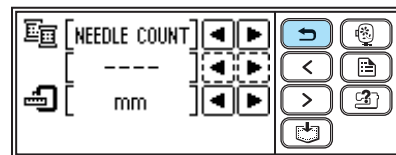

- 3 Press (Embroidery key).

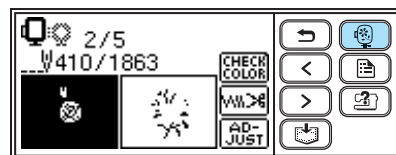

▶ The confirmation message is displayed.

4 Press **OK**.



- ▶ The selected pattern is deleted, and the screen for selecting the embroidery pattern type is displayed.

5 Turn off the machine.

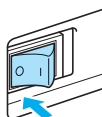

### Note

- Always remove the embroidery unit when you move the machine.

6 Turn on the machine, and then select the pattern.



### Memo

- If you have changed the embroidery size and/or layout before turning off the machine, make the same setting changes again before restarting embroidering. For details, refer to "Adjusting the layout and the size" (page 61).

7 Press **AD-JUST**.

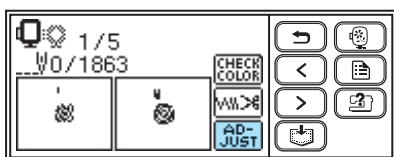

8 Press **W-4**.



9 Press **←** (Forward one color) to move to the beginning of the color you want to embroider.

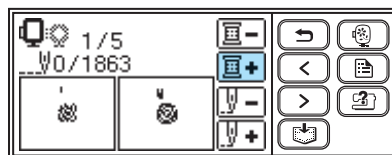

10 Press **W+** (Forward one stitch) to increase the needle count.

If **W+** is pressed continuously, it moves forward 1 → 9 → 30 stitches.



Move forward to about 10 stitches before the total number of stitches confirmed in 2.



11 Restart the embroidery.

## Using the Memory Function

### Embroidery data precautions

Observe the following precautions when using embroidery data other than that created and saved in this machine.

#### CAUTION

- **When using embroidery data other than our original patterns, the thread or needle may break when sewing with a stitch density that is too fine or when sewing three or more overlapping stitches. In that case, use one of our original data design systems to edit the embroidery data.**

#### ■ Types of Embroidery Data that can be Used

- Only .pes and .dst embroidery data files can be used with this machine. Using data other than that saved using our data design systems or machines may cause the embroidery machine to malfunction.

#### ■ Computers and Operating Systems with the Following Specifications can be Used

- Compatible models:  
IBM PC with a USB port as standard equipment  
IBM PC-compatible computer equipped with a USB port as standard equipment
- Compatible operating systems:  
Microsoft Windows Me/Windows 2000/Windows XP/Windows Vista/Windows 7  
(Windows 98SE requires a driver. Download the driver from our web site “ <http://solutions.brother.com> ”.)

#### ■ Precautions on Using the Computer to Create and Save Data

- If the file name of embroidery data cannot be identified, for example, because the name contains special characters, the file is not displayed. If this occurs, change the name of the file. We recommend using the 26 letters of the alphabet (uppercase and lowercase), the numbers 0 through 9, “-”, and “\_”.
- .pes files saved with the number of stitches, the number of colors and the number of combined patterns exceeding the specified limits cannot be displayed. Use one of our original data design systems to edit the embroidery pattern so that it meets the specifications.
- Do not create folders in “Removable Disk” on a computer. If embroidery data is saved in a folder in “Removable Disk”, that embroidery data cannot be retrieved by the machine.
- Even if the embroidery unit is not attached, the machine will manage embroidery data.

#### ■ Tajima (.dst) Embroidery Data

- .dst data is displayed in the pattern list screen by file name (the actual image cannot be displayed). Only the first eight characters of the file name can be displayed.
- Since Tajima (.dst) data does not contain specific thread color information, it is displayed with our default thread color sequence. Check the preview and change the thread colors as desired.

#### ■ Trademarks

- IBM is a registered trademark or a trademark of International Business Machines Corporation.
- Microsoft and Windows are registered trademarks or trademarks of Microsoft Corporation.

Each company whose software title is mentioned in this manual has a Software License Agreement specific to its proprietary programs.

All other brands and product names mentioned in this manual are registered trademarks of their respective companies. However, the explanations for markings such as ® and ™ are not clearly described within the text.

## Saving patterns

The embroidery patterns and the alphanumeric characters you have customized can be saved in the machine's memory.

Since the saved patterns will not be erased when the power is turned off, you can always retrieve them for embroidery. This is convenient for saving names and the like. You can save up to 12 patterns or 512KB of data.

### ■ Saving a pattern

- ① After selecting the pattern to be saved, press  (Memory key).



- ▶ "Saving..." appears while the pattern is being saved. After the pattern is saved, the initial screen appears again.



### Note



- Do not turn off the machine while the pattern is being saved, otherwise the pattern data may be lost.

### ■ Retrieving a pattern

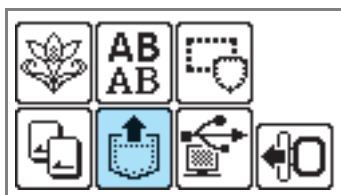
- ① Press  (Retrieve key).



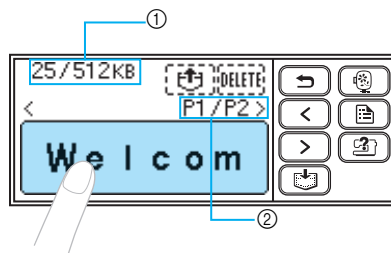

- ▶ The saved patterns are displayed.

- ② Select the pattern you wish to retrieve.  
Switch screens using  (Previous page key) and  (Next page key).



- ① Total amount of memory used/Total amount of memory space  
② Number of the currently displayed page from the total number of pages

- ▶ The selected pattern is shown in reverse highlighting.

- ③ Press .  
To delete the saved pattern, press .



- ▶ The saved pattern is retrieved.  
▶ The embroidery screen appears, and you can embroider the retrieved pattern.

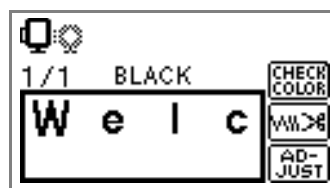



## Retrieving embroidery patterns from the computer

- 1 Plug the USB cable connectors into the corresponding USB port connectors on the computer and on the machine.

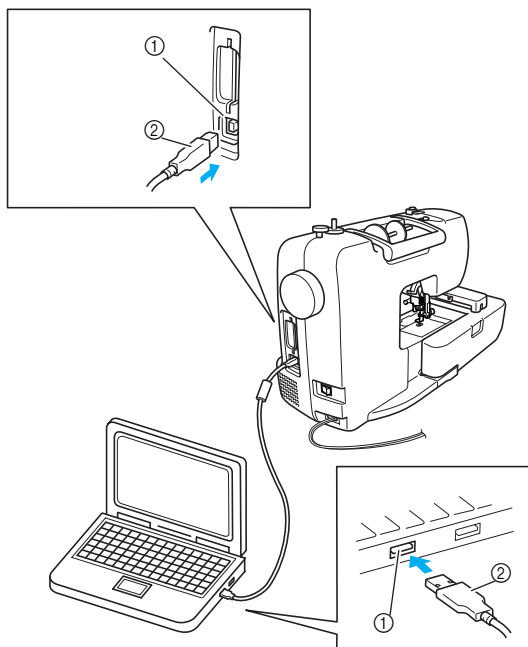

- ① USB port connector for computer
- ② USB cable connector

### Memo

- The USB cable can be plugged into the USB port connectors on the computer and machine whether or not they are turned on.
- Embroidery patterns can be retrieved with or without the embroidery unit attached to the machine.

- 2 The "Removable Disk" icon appears in "My Computer" on the computer.

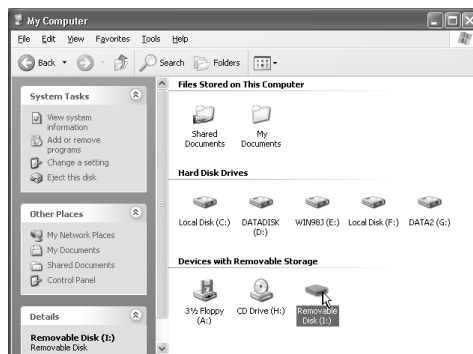

- 3 Copy the pattern data to "Removable Disk".

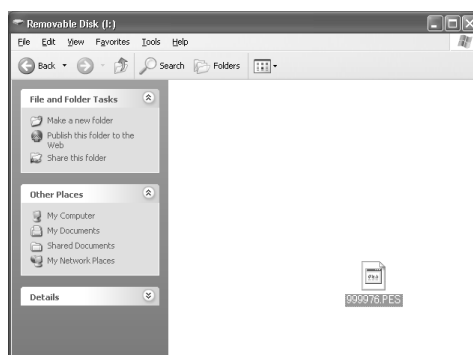

- ▶ Pattern data in "Removable Disk" is written to the machine.

### Note

- While data is being written, do not disconnect the USB cable.
- Do not create folders within "Removable Disk". Since folders are not displayed, pattern data within folders cannot be retrieved.
- While the machine is embroidering, do not write data to or delete data from "Removable Disk".

- 4 Press .

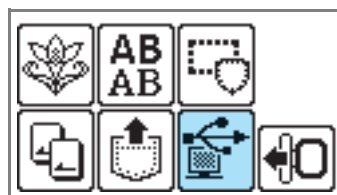

- ▶ The saved patterns are displayed.

## 5 Select the pattern you wish to retrieve.

Switch screens using  (Previous page key) and  (Next page key).

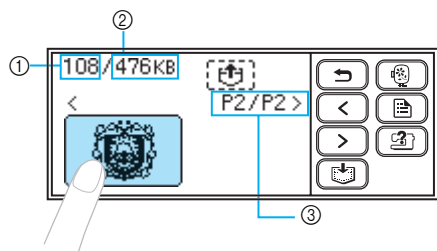

- ① Total amount of memory used
- ② Total amount of memory space
- ③ Number of the currently displayed page from the total number of pages

▶ The selected pattern is shown in reverse highlighting.

## 6 Press .



- ▶ The saved pattern is retrieved.
- ▶ The embroidery screen appears, and you can embroider the retrieved pattern.

## 7 Adjust the pattern as desired, and then begin embroidering.



## Note

- If there are 13 or more patterns saved in "Removable Disk", the patterns cannot be displayed. When the message "Reduce the number of patterns. Only up to 12 patterns can be handled." appears, delete patterns from "Removable Disk" so that it contains no more than 12 patterns. Then, close the error message, repeat the procedure starting from step 4 and then press  to retrieve the pattern.
- If patterns copied to "Removable Disk" are not saved in the machine's memory, their data is lost when the machine is turned off. In order to retrieve patterns directly from the machine the next time that they are needed, save the data in the machine's memory before turning off the machine. For details, refer to "Saving patterns" (page 70).



## APPENDIX

The various maintenance and troubleshooting procedures are described in this chapter.

Care and Maintenance .....	74
Attaching the Embroidery Foot.....	76
Troubleshooting .....	78
Upgrading Your Machine's Software.....	86
Index .....	87

## Care and Maintenance

Simple machine maintenance operations are described below.

### Cleaning the machine surface

If the surface of the machine is dirty, lightly soak a cloth in neutral detergent, squeeze it out firmly, and then wipe the surface of the machine. After cleaning it once with a damp cloth, wipe it again with a dry cloth.

#### **CAUTION**

- **Unplug the power supply cord before cleaning the machine. Otherwise, injuries or an electric shock may occur.**

### Cleaning the race

Embroidery performance will suffer if dust collects in the bobbin case. Therefore, it should be cleaned periodically.

- 1 Turn off the machine.

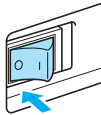

- 2 Unplug the power supply cord from the power supply jack on the right side of the machine.

#### **CAUTION**

- **Unplug the power supply cord before cleaning the machine. Otherwise, injuries or an electric shock may occur.**

- 3 Remove the embroidery unit.

- 4 Loosen the needle clamp screw and remove the needle (page 28).

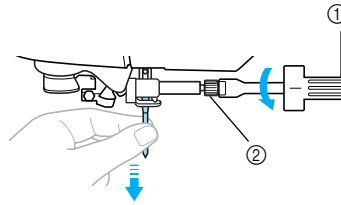

- ① Screwdriver
- ② Needle clamp screw

- 5 Grasp both sides of the needle plate cover, and then slide it toward you.

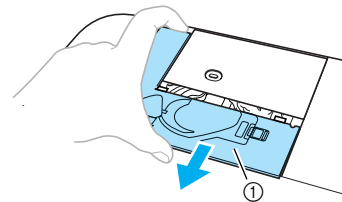

- ① Needle plate cover
- ▶ The needle plate cover is removed.

- 6 Remove the bobbin case. Grasp the bobbin case, and then pull it out.

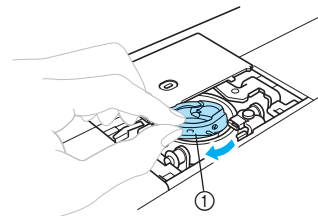

- ① Bobbin case

- 7** Use the cleaning brush or a vacuum cleaner to remove any lint and dust from the race and bobbin thread sensor and their surrounding area.

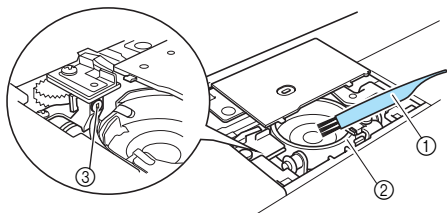

- ① Cleaning brush
- ② Race
- ③ Bobbin thread sensor



**Note**

- Do not apply oil to the bobbin case.
- If lint or dust collects on the bobbin thread sensor, the sensor may not operate correctly.

- 8** Insert the bobbin case so that the  $\Delta$  mark on the bobbin case aligns with the  $\circ$  mark on the race.

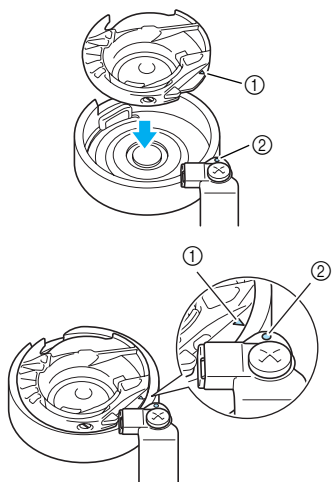

- Align the  $\Delta$  and  $\circ$  marks.

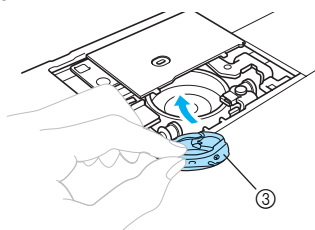

- ①  $\Delta$  mark
- ②  $\circ$  mark
- ③ Bobbin case

- Make sure that the indicated points are aligned before installing the bobbin case.

- 9** Insert the tabs on the needle plate cover into the needle plate, and then slide the cover back on.

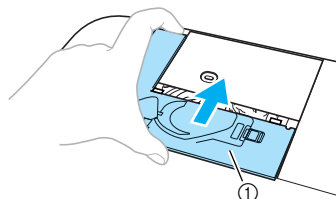

- ① Needle plate cover

**CAUTION**

- Never use a bobbin case that is scratched. Otherwise, the upper thread may become tangled, the needle may break or embroidering performance may suffer. For a new bobbin case (part code: XD1855-351), contact your nearest authorized service center.
- Be sure that the bobbin case is correctly installed, otherwise the needle may break.

## Attaching the Embroidery Foot

This section describes how to attach the embroidery foot "Q".

### Attaching the embroidery foot

If you need to replace the embroidery foot, attach the embroidery foot "Q" as follows.

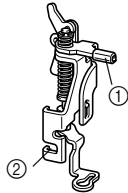

- ① Embroidery foot bar
- ② Caught by the presser foot holder screw

#### CAUTION

- Always use the embroidery foot "Q" when embroidering. If the wrong embroidery foot is used, the needle may hit the embroidery foot and bend or break.

- 1 Press  (Needle position button) once or twice to raise the needle.

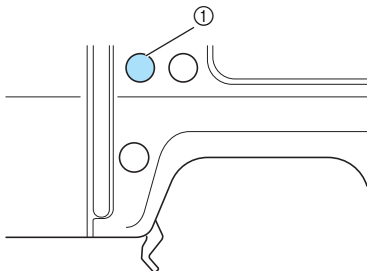

- ① Needle position button



#### Note

- The needle is correctly raised when the mark on the handwheel is at the top. Check the handwheel mark is at the top position.

- 2 Turn off the machine.

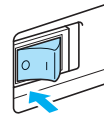

#### CAUTION

- Before attaching the embroidery foot, be sure to turn off the machine. Otherwise, injuries may occur if one of the operation buttons is accidentally pressed and the machine starts embroidering.

- 3 Raise the presser foot lever.

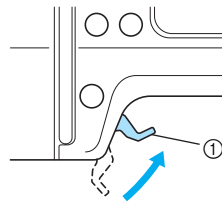

- ① Presser foot lever

- 4 Hold the embroidery foot "Q" with your right hand, as shown.

Hold the embroidery foot with your index finger wrapped around the lever at the back of the foot.

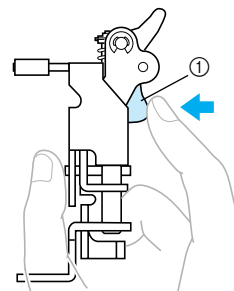

- ① Lever

- 5** While pressing in the lever with your finger, fit the embroidery foot bar over the needle clamp screw to attach the embroidery foot to the presser foot bar.

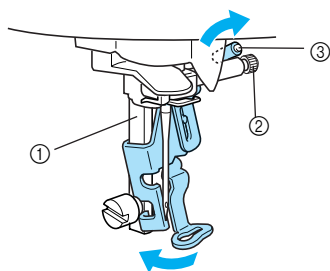

- ① Presser foot bar
- ② Needle clamp screw
- ③ Embroidery foot bar

- 6** Secure the embroidery foot with the presser foot holder screw. Set the embroidery foot perpendicular.

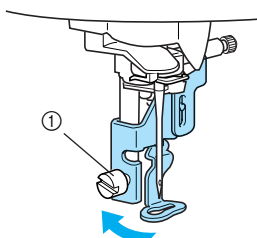

- ① Presser foot holder screw

- 7** Firmly tighten the presser foot holder screw. Turn the screwdriver toward the front.

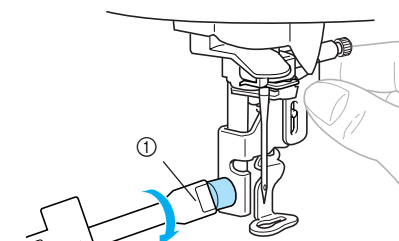

- ① Screwdriver

### **!** CAUTION

- Do not hit the needle with your finger or the embroidery foot when attaching it. The needle may break or cause injury.
- Be sure to tighten the screw with the included screwdriver. If the screw is loose, the needle may hit the embroidery foot and break or bend.
- Before embroidering, always turn the handwheel toward you (counterclockwise) slowly to make sure that the needle does not hit the embroidery foot. The needle may break or bend.

## Troubleshooting

If the machine stops operating correctly, check the following possible problems before requesting service. You can solve most problems by yourself. If you need additional help, the Brother Solutions Center offers the latest FAQs and troubleshooting tips. Visit us at [<http://solutions.brother.com>].

If the problem persists, contact your dealer or the nearest authorized service center.

Symptom	Probable Cause	Remedy	Reference
The machine does not operate.	The machine is not turned on.	Turn on the machine.	page 18
	The start/stop button was not pressed.	Press the start/stop button.	page 58
	The presser foot lever is raised.	Lower the presser foot lever.	page 58
	The bobbin winder shaft is on the right side after winding the bobbin.	Slide the bobbin winder shaft to the left.	page 33
	The embroidery unit is not attached on the machine.	Attach the embroidery unit.	page 19
The needle breaks.	The needle is incorrectly installed.	Correctly install the needle.	page 28
	The needle clamp screw is loose.	Use the screwdriver to firmly tighten the screw.	
	The needle is bent or blunt.	Replace the needle.	
	The upper thread tension is too tight.	Loosen the upper thread tension.	page 63
	The spool is incorrectly installed.	Correctly install the spool.	page 37
	The area around the hole in the needle plate is scratched, or has a burr on it.	Replace the needle plate. Contact your dealer or the nearest authorized service center.	-
	The area around the hole in the embroidery foot is scratched, or has a burr on it.	Replace the embroidery foot. Contact your dealer or the nearest authorized service center.	-
	The bobbin case is scratched, or has a burr on it.	Replace the bobbin case. Contact your dealer or the nearest authorized service center.	-
	A bobbin designed specifically for this machine is not used.	Incorrect bobbins will not work properly. Only use a bobbin designed specifically for this machine.	page 29
The upper thread was not threaded correctly.	Correct the upper threading.	page 38	
The upper thread breaks.	The upper thread was not threaded correctly (for example, the spool is not installed correctly, the spool cap is too big for the spool being used, or the thread has come out of the needle bar thread guide.)	Correct the upper threading. Use the spool cap that best fits the size of the spool being used.	page 37











Symptom	Probable Cause	Remedy	Reference
The upper thread breaks.	There are knots or tangles in the thread.	Remove any knots or tangles.	-
	The upper thread tension is too tight.	Loosen the upper thread tension.	page 63
	The thread is tangled, for example, in the bobbin case.	Remove the tangled thread. If the thread is tangled in the bobbin case, clean the race.	page 74
	The needle is bent or blunt.	Replace the needle.	page 28
	The needle is incorrectly installed.	Correctly install the needle.	
	The area around the hole in the embroidery foot is scratched, or has a burr on it.	Replace the embroidery foot. Contact your dealer or the nearest authorized service center.	-
	The bobbin case is scratched, or has a burr on it.	Replace the bobbin case. Contact your dealer or the nearest authorized service center.	-
	A bobbin designed specifically for this machine is not used.	Incorrect bobbins will not work properly. Only use a bobbin designed specifically for this machine.	page 29
Bobbin thread does not wind neatly on the bobbin.	The thread is not passed through the bobbin-winding thread guide correctly.	Correctly pass the thread through the bobbin-winding thread guide.	page 31
	The thread that was pulled out was not wound onto the bobbin correctly.	Wind the thread that was pulled off around the bobbin five or six times clockwise.	page 32
The lower thread is tangled or breaks.	The bobbin thread is incorrectly installed.	Correctly install the bobbin thread.	page 34
	The bobbin is scratched or does not rotate smoothly, or has a burr on it.	Replace the bobbin.	-
	The thread is tangled.	Remove the tangled thread and clean the race.	page 74
	A bobbin designed specifically for this machine is not used.	Incorrect bobbins will not work properly. Only use a bobbin designed specifically for this machine.	page 29
The thread is tangled on the wrong side of the fabric.	The upper thread was not threaded correctly.	Correct the upper threading.	page 38
The thread tension is incorrect.	The upper thread was not threaded correctly.	Correct the upper threading. Make sure that the thread is hanged on the thread guide spring which is on the left side of the thread guide cover.	page 38, page 39
	The bobbin thread is incorrectly installed.	Correctly install the bobbin thread.	page 34

Symptom	Probable Cause	Remedy	Reference
The thread tension is incorrect.	The thread tension is incorrect.	Adjust the tension of the upper thread and the bobbin thread.	page 63, page 64
	A bobbin designed specifically for this machine is not used.	Incorrect bobbins will not work properly. Only use a bobbin designed specifically for this machine.	page 29
The upper thread is too tight.	The bobbin thread is incorrectly installed.	Correctly install the bobbin thread.	page 34
Stitches are skipped.	The upper thread was not threaded correctly.	Correct the upper threading.	page 38
	The needle is bent or blunt.	Replace the needle.	page 28
	The needle is incorrectly installed.	Correctly install the needle.	page 28
	Dust has accumulated under the needle plate or in the bobbin case.	Remove the needle plate cover and clean the race.	page 74
A high-pitched noise is made while embroidering.	Dust has accumulated in the bobbin case.	Clean the race.	page 74
	The upper thread was not threaded correctly.	Correct the upper threading.	page 38
	The bobbin case is scratched, or has a burr on it.	Replace the bobbin case. Contact your dealer or the nearest authorized service center.	-
	A bobbin designed specifically for this machine is not used.	Incorrect bobbins will not work properly. Only use a bobbin designed specifically for this machine.	page 29
The thread does not pass through the eye of the needle.	The needle has not been raised to the correct position.	Press the needle position button.	page 38
	The needle is incorrectly installed.	Correctly install the needle.	page 28
The stitch is not sewn correctly.	The thread tension is incorrect.	Adjust the tension of the upper thread and the bobbin thread.	page 63, page 64
	The thread is tangled, for example, in the bobbin case.	Remove the tangle thread. If the thread is tangled in the bobbin case, clean the race.	page 74
The needle threader lever does not lower to the correct position.	The needle has not been raised to the correct position.	Press the needle position button.	page 38
The lamps do not come on.	The lamps are damaged.	Contact your dealer or the nearest authorized service center.	-
	The machine is not turned on.	Turn on the machine.	page 18
Nothing appears in the LCD.	The brightness of the LCD is either too light or too dark.	Adjust the brightness of the LCD.	page 85







Symptom	Probable Cause	Remedy	Reference
Embroidery unit does not move.	No pattern selected.	Select a pattern.	page 50
	The embroidery unit is not set up correctly.	Set the embroidery unit up correctly.	page 19
Embroidery not neatly done.	The fabric is not fully stretched on the embroidery frame. The fabric is loose.	Stretch the fabric properly on the embroidery frame.	page 44
	No stabilizer material is attached.	Always use stabilizer material for embroidery.	page 43
	The thread is tangled and the bobbin case, etc., is plugged up.	Remove the tangled thread. When the bobbin case is plugged up, clean the race.	page 74
	The thread tension is incorrect.	Adjust the tension of the upper thread and the bobbin thread.	page 63, page 64
	The upper thread was not threaded correctly.	Correct the upper threading. Make sure that the thread is hanged on the thread guide spring which is on the left side of the thread guide cover.	page 38, page 39
	The bobbin thread is incorrectly installed.	Correctly install the bobbin thread.	page 34
	Objects are placed near the carriage or embroidery frame.	If the embroidery unit carriage or embroidery frame bumps into objects, the pattern will be misaligned. Do not place objects within the range of embroidery frame motion.	page 58
	Material coming out of the embroidery frame is causing problems.	Stretch the fabric on the frame once again so that the material coming out of the embroidery frame does not cause problems, rotate the pattern and embroider.	-
	A heavy fabric is being embroidered, and the fabric is hanging off the table.	If embroidery is done with the fabric hanging off the table, the embroidery unit movement will be impaired. Support the fabric while embroidering.	-
	The fabric is catching. It is pinched.	Stop the machine and set the fabric up correctly.	-
The carriage was moved while the embroidery frame was being removed or attached during embroidery.	If the carriage is moved during the process, the pattern may be misaligned. Be careful when removing or attaching the embroidery frame.	-	

## Error messages

When erroneous operations are performed messages and advice on operation will be displayed on the LCD. Follow what is displayed. If you press **CLOSE** or do the operation correctly while the error message is displayed, the message disappears.

No	Error Message	Probable Cause
1	 Can not recognize the data. The data may be corrupted.	There is a possibility that the data for the selected pattern is corrupted.
2	 Cannot sew on this screen.	The start/stop button was pressed at a screen other than the embroidery screen.
3	 Check and rethread the upper thread.	Upper thread broken. Upper thread not set up correctly. Upper thread has run out.  <b>CAUTION</b> <b>Be sure to rethread the machine. If you press  (Start/stop button) without rethreading the machine, the thread tension may be wrong or the needle may break and cause injury.</b>
4	Deleting...	The machine is deleting a previously saved pattern while in embroidery edit mode.
5	 Do not send a USB transmission while embroidering.	While embroidering, data is written to the "Removable Disk" in the connected computer or data is deleted from the "Removable Disk".
6	 Insert an embroidery card.	 on the LCD was pressed when no card was inserted.
7	 Lower the presser foot lever.	The start/stop button or thread cutter button was pressed while the embroidery foot was raised.
8	 Not enough available memory. Delete another pattern?	The memory is full and the pattern cannot be saved.

No	Error Message	Probable Cause
9	ⓘ OK to delete the selected pattern?	You pressed the back key or the embroidery key when a pattern was selected.
10	ⓘ Press the needle position button to raise the needle.	You tried to select an embroidery pattern or change the layout when the needle was down. The machine is turned on while the needle is lowered and the embroidery unit is attached.
11	ⓘ Raise presser foot lever.	You tried to initialize the embroidery unit with the embroidery foot lowered.
12	ⓘ Reduce the number of patterns. Only up to 12 patterns can be handled.	When 13 or more patterns are in "Removable Disk", a pattern was being retrieved.
13	ⓘ Retrieve the pattern.	The start/stop button was pressed after selecting a pattern which is saved in the machine's memory or entered from the USB port without pressing  (Retrieve key).
14	ⓘ Return the bobbin winding shaft to left.	The needle position button or thread cutter button was pressed while the bobbin winder shaft is moved to the right.
15	Saving...	A pattern is being saved.
16	ⓘ Select a pattern.	The start/stop button was pressed when no pattern is selected.
17	ⓘ The bobbin thread is running out.	Bobbin thread has run out. Little bobbin thread remains.

No	Error Message	Probable Cause
18	 The carriage of the embroidery unit will move.	When the embroidery unit is attached.
19	 The pattern is too large for the embroidery frame.	You tried to set a number of characters that will not fit within the frame.
20	 The safety device has been activated.	The upper thread has become tangled around the bobbin case, and the needle is bent and hitting the needle plate, etc., so the machine stops (refer to page 78).
21	 This embroidery card can not be used on this machine.	An Embroidery Memory Card that may not compatible with your machine has been inserted. <ul style="list-style-type: none"> <li>• Certain licensed designs cannot be read by this machine.</li> <li>• Designs in an unacceptable card format cannot be read by this machine.</li> <li>• Design data saved in a hoop size not compatible with your machine has been selected.</li> </ul>
22	 This pattern cannot be used.	You try to retrieve a pattern downloaded as one for a different machine.
23	 Turn off the machine, and attach the embroidery unit.	The start/stop button, the embroidery key, or the memory key is pressed, but the embroidery unit is not attached. The embroidery key was pressed when the embroidery unit is not attached.
24	Winding bobbin thread...	The bobbin winder is winding the bobbin.

## Adjusting the LCD

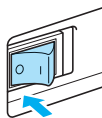

If nothing appears in the LCD when the machine is turned on, the brightness of the LCD is either too light or too dark. In such a case, perform the following operation.

- 1 Turn off the machine.

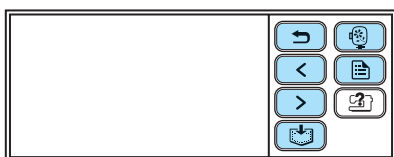

- 2 Turn on the machine while pressing any of the operation panel keys except  (Help key).



- 3 Press  or .



- 4 Turn off the machine, then turn it on again.

## Operation beep

Each time a key is pressed you will hear one beep. If an incorrect operation is performed you will hear two or four beeps.

- **If a key is pressed (correct operation)**  
One beep sounds.
- **If an incorrect operation is performed**  
Two or four beeps sound.

- **If the machine locks up, for example, because the thread is tangled**

The machine beeps for four seconds and the machine automatically stops.

Be sure to check for the cause of the error, and correct it before continuing to embroider.

- **Canceling the operation beep**

When the machine is purchased, it is set to beep each time an operation panel key is pressed. This setting can be changed so that the machine does not beep.

- 1 Turn on the machine.

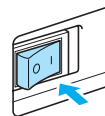

▶ The LCD comes on.

- 2 Press  (Setting key) in the operation panel.

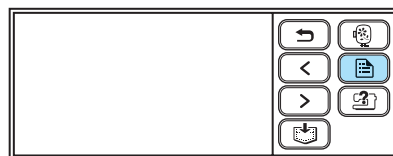

▶ The setting screen appears.

- 3 Press  (Next page key) twice.

- 4 Press OFF for the buzzer.



▶ The screen for changing the beep setting appears.

- 5 Press  (Back key).



▶ The initial screen appears again.

## Upgrading Your Machine's Software

You can use a computer to download software upgrades for your machine. Visit our website at "<http://solutions.brother.com>" for notification of available updates.



### Note

- Be sure to download the upgrade file for this model from our web site. An upgrade file for any different model cannot be downloaded.
- Refer to the "Changing the machine settings" (page 23) for how to check the version of the machine's software.



### Memo

- The embroidery pattern which is saved in the machine will not be deleted if you upgrade the software.
- While the software is being upgraded, the buzzer will not sound when a key is pressed.

- 1 While holding  (Help key) pressed, turn on the machine.

- ▶ The following screen appears.

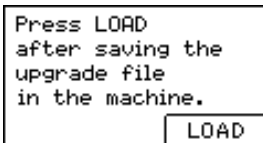

- 2 Plug the USB cable connectors into the corresponding USB ports on the computer and on the machine.

- ▶ The "Removable Disk" icon appears in "My Computer" on the computer.

- 3 Copy the upgrade file to "Removable Disk".

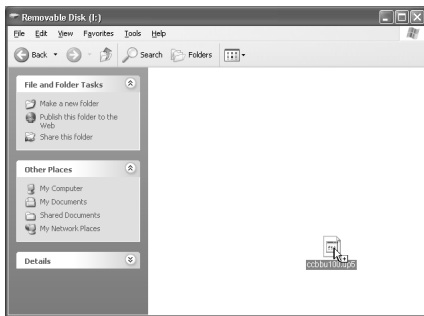

- ▶ The message "Connected to PC. Do not disconnect the USB cable." appears.

- 4 When the screen shown in step 1 appears again, press .

- ▶ The message "Saving the upgrade file. Do not turn main power to OFF." appears.

- 5 When the following screen appears, upgrading is completed.

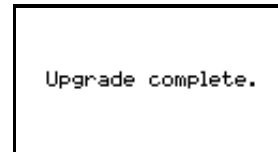

### Note

- If an error occurred, an error message appears. At this time, turn the machine off, and then start the procedure again from step 1.

- 6 Disconnect the USB cable, and turn the machine off, then on again.



# Index

<b>A</b>	
accessories .....	8, 9
adjusting layout .....	61
adjusting thread tension .....	63, 64
air vent .....	11
appliqué pattern selection .....	59
attaching stabilizer material .....	43
attributes .....	23
<b>B</b>	
back key .....	13
basic steps for embroidering .....	16
beep .....	85
bobbin .....	29
bobbin case removal .....	74
bobbin cover .....	11
bobbin installation .....	34
bobbin thread tension .....	64
bobbin winder .....	10
bobbin winder seat .....	33
bobbin winding .....	29
bobbin-winding thread guide .....	10, 31
buzzer .....	85
<b>C</b>	
care .....	74
checking needle .....	27
cleaning bobbin case .....	74
cleaning brush .....	8
cleaning machine surface .....	74
connecting character patterns .....	65
country thread .....	23, 26, 51
<b>E</b>	
embroidering .....	16, 57
embroidering pattern .....	57
embroidery card .....	55
embroidery card slot .....	11, 56
embroidery character selection .....	53
embroidery data .....	69
embroidery foot installation .....	76
embroidery frame .....	44
embroidery frame installation .....	47
embroidery frame removal .....	48
embroidery key .....	13
embroidery pattern selection .....	50
embroidery pattern types .....	50
embroidery set .....	8
embroidery sheet .....	45
embroidery threads .....	26
embroidery unit connector slot .....	10
embroidery unit installation .....	19
embroidery unit removal .....	21
error messages .....	82
<b>F</b>	
frame pattern selection .....	55
front view .....	10
<b>H</b>	
handle .....	11
handwheel .....	11
help key .....	13
<b>I</b>	
installing bobbin .....	34
<b>L</b>	
layout adjustment .....	61
LCD .....	22
LCD button .....	52
LCD messages .....	82
LCD operation .....	22
<b>M</b>	
machine surface cleaning .....	74
main power switch .....	11
maintenance .....	74
manual needle threading .....	42
memory key .....	13
<b>N</b>	
needle bar thread guide .....	11
needle condition .....	27
needle plate .....	11
needle plate cover .....	11
needle position button .....	12
needle replacement .....	28
needle set .....	8
needle threader lever .....	10
needle threading .....	37
needles .....	27
next page key .....	13
<b>O</b>	
operation beep .....	85
operation buttons .....	10, 12
operation keys .....	13
operation panel .....	10, 13
operation problems .....	78
operations .....	25
optional accessories .....	9
<b>P</b>	
pattern embroidery .....	57

pattern retrieving .....	70, 71
plug .....	18
power supply cord .....	18
power supply jack .....	18
power switch .....	11, 18
presser foot lever .....	10
previous page key .....	13

## Q

---

quick reference guide .....	8
-----------------------------	---

## R

---

race .....	74
release button .....	21
replacing needle .....	28
resewing .....	66
retrieving pattern .....	70, 71

## S

---

safety instructions .....	1
saving patterns .....	70
seam ripper .....	8
selecting alphanumeric characters .....	53
selecting embroidery patterns .....	50
settings key .....	13
solving operation problems .....	78
spool cap .....	8, 30, 38
spool net .....	8, 31
spool of thread .....	37
stabilizer material .....	43
start/stop button .....	12
stopping embroidering .....	67

## T

---

thread cutter .....	10
thread cutter button .....	12
thread guide .....	10, 31, 39
thread guide cover .....	10, 31, 39
thread guide disk .....	11, 40
thread spools .....	37
thread take-up lever .....	10, 40
thread tension adjustment .....	63, 64
threading .....	37
threading bobbin .....	29
threading needle .....	37
threading needle manually .....	42
touch panel .....	13
troubleshooting .....	78
turning machine on/off .....	17

## U

---

upgrading .....	86
upper thread .....	37
upper thread spool .....	37
upper thread tension .....	63
upper threading .....	37
USB cable .....	71
USB port connector .....	71

## W

---

winding bobbin .....	29
----------------------	----





XE5427-201③

English  
885-V51  
Printed in China